

2017/18

25
Years

Orthodontic Catalogue

The Orthodontic Company

Orthodontic & Specialist Dental Supplies



discover the difference

TOC - Established over 25 years



Discover the difference

Welcome to our latest catalogue packed full of new and innovative orthodontic products.

We are proud to be celebrating our 25th anniversary having grown into one of the UK's largest orthodontic companies with the most comprehensive product range.

Our aim is to provide high quality products combined with excellent customer service. We offer a range of products to suit all budgets and with prices that represent true value for money.

With one of the largest independent sales teams in the UK dedicated to orthodontics we are able to work closely with you to help understand your needs and assist in product choice.

We are an ISO accredited company and continually assess the quality of the products we supply to ensure the highest standard. Extensive stocks are held in our UK distribution centre in Bristol ready for next day delivery.

TOC also has a comprehensive range of high quality Laboratory products. Visit our dedicated website www.toclaboratory.com or call our Lab line **0117 907 5558** for more information.

- Dedicated Orthodontic Supply Company
- Knowledgeable Sales Team
- Largest Orthodontic Range in the UK
- True Value for Money Products

Thank you for choosing TOC for your orthodontic requirements.

**Dentsply
Sirona**
Orthodontics
Exclusive UK Distributor

 Find us on Facebook
facebook.com/tocdental

How to order

Your account no.

T: 0117 975 5533

Order Monday - Friday 9:00 am until 5:00 pm
Answer phone available out of hours.

F: 0117 975 5575

Use your fax machine to order
24 hours a day, 7 days a week.

E: info@tocdental.com

W: www.tocdental.com

Use the internet to place your order 24 hours a day,
7 days a week. Get up-to-the-minute information on
new products and services we offer.

**M: TOC, The Old Church,
Collins Street, Avonmouth,
Bristol BS11 9JJ**





















Be sure to include your name and phone number
or email address in case of any query.

Payment methods

Cheque, BACS, Visa, MasterCard, American Express and Maestro are all accepted methods of payment. Payment is to be made within 30 days net from date of invoice. Normal terms & conditions apply.



Table of Contents

	Aesthetic Bracket Systems.....	5
	Metal Brackets Systems.....	15
	Lingual Brackets Systems.....	29
	Molar Bands and Buccal Tubes.....	33
	Wire Products.....	39
	Attachments and Retention.....	56
	Temporary Anchorage Device.....	62
	Allergy Control Products.....	64
	Elastomerics.....	66
	Bonding Supplies.....	72
	Headgear Products.....	86
	Impression Supplies.....	88
	Vacuum Forming.....	97
	Interproximal Stripping and Burs.....	101
	Patient Care.....	107
	Photography.....	119
	Instruments.....	123
	Organisers.....	138
	Terms & Conditions.....	140
	Index.....	141



Slim - Elegant - Beautiful

See
p123-128 for
our complete
range of
Tennis
instruments

- Resist™ Stainless Steel cutting tips for reliability and superior cutting action
- Ergonomic Design - user friendly
- Satin finish to reduce glare

A Collection of High Quality
Orthodontic Instruments

For
Lingual
Brackets
see pages
29-32



Self-Ligating Ceramic



Advanced Ceramic



Advanced Polysapphire



Ceramic



Composite

AESTHETIC BRACKET SYSTEMS

In-Ovation® C

Premium Aesthetic Self-Ligating Bracket System

Aesthetics without Compromise

In-Ovation C is the world's premier ceramic, self-ligating bracket system. *DENTSPLY GAC* has translated the proven clinical benefits of In-Ovation R into a functional, attractive ceramic design.

In-Ovation C's exceptionally high translucency and rhodium coated clip provide superb aesthetics - a marketable advantage that appeals to patients of all ages. In-Ovation C means you can handle more cases while enhancing both the patient experience and the treatment outcome.

Satisfied Patients and Staff

In-Ovation C is easy for orthodontists and staff to use, while it delivers superb results with enhanced aesthetics and comfort for patients. Designed for reliable performance, the bracket's 100% mechanical lock base ensures reliable bonding and debonding. Its innovative clip technology is easy to use: closing with a nudge of a thumb with an audible "click" to assure correct engagement. A special interactive Coballoy spring clip provides better torque expression while its special design ensures easy opening and easy closing throughout the treatment - a full arch change takes seconds!

Reduced Treatment Time

Whichever technique you employ, the In-Ovation C system is designed to provide predictable results and shorter overall treatment times. The bracket's spring clip gently controls rotations throughout treatment, while its true rectangular slot helps deliver precise torque and control. In-Ovation C provides optimal inter-bracket distance while yielding straight wire results.



Smooth Swept Tie Wings

Minimising occlusal interference and increasing patient comfort

Compound Contoured Base

For a precise anatomical fit

100% Mechanical Base

For reliable bonding, debonding and ability to rebond

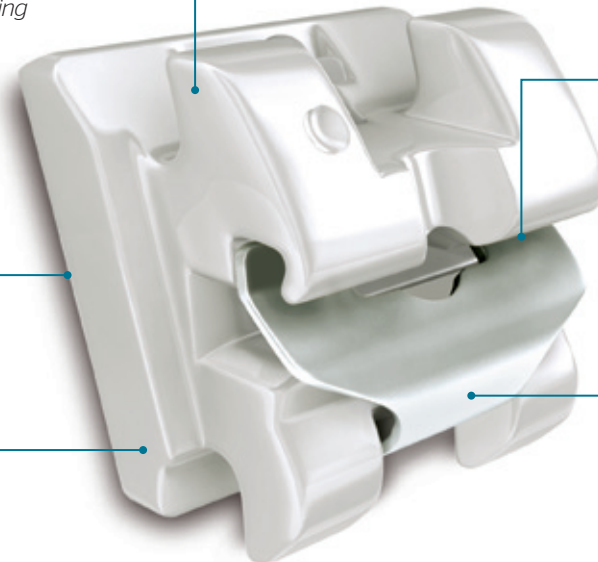

Chamfered Archwire Slot

For facilitating wire engagement and reducing binding

Unique Rhodium Coated Clip

For optimal aesthetics



Treat your patients with confidence.
The first choice aesthetic self-ligating
bracket system since 2006



The Power of Interactive Control From Start to Finish



Passive Mode

Small, round wires slide freely, initiating the tooth movement process as the archwire gently levels teeth and coaxes them into alignment.



Expressive Mode

Square or rectangular wires are gently seated into the base of the slot without contacting the clip. Programming is expressed, rotations are corrected and space closures are completed.



Active Mode

Rectangular archwires extend beyond the slot to fully engage the clip, providing the active control necessary for functional finishing, uprighting of the roots and adjusting torque.

ROTH* .022"	T	A	R	RIGHT	LEFT
U1	12°	5°	0	100-112-00	100-212-00
U2	8°	9°	0	100-122-00	100-222-00
U3	-2°	13°	4M	100-132-00	100-232-00
U3 + Hook	-2°	13°	4M	100-132-10	100-242-10
U4/5	-7°	0°	2D	100-142-00	100-242-00
U4/5 + Hook	-7°	0°	2D	100-142-10	100-242-10
L1/2	-1°	2°	0	100-312-00	100-412-00
L3	-11°	7°	2M	100-332-00	100-432-00
L3 + Hook	-11°	7°	2M	100-332-10	100-432-10
L4 (Zirconia)	-17°	-1°	4D	100-342-00	100-442-00
L5 (Zirconia)	-22°	-1°	4D	100-352-00	100-452-00

EURO (MBT*) .022"	T	A	R	RIGHT	LEFT
U1	17°	4°	0	100-112-80	100-212-80
U2	10°	9°	0	100-122-80	100-222-80
U3 + Hook	-7°	8°	0	100-132-81	100-232-81
U4	-7°	0°	0	100-542-80	
U4 + Hook	-7°	0°	0	100-542-81	
U5	-7°	0°	0	100-552-80	
U5 + Hook	-7°	0°	0	100-552-81	
L1/2	-6°	0°	0	100-612-80	
L3 + Hook	-6°	3°	0	100-332-81	100-432-81
L4 (In-Ovation R)	-12°	2°	0	189-342-80	189-442-80
L5 (In-Ovation R)	-17°	2°	0	189-352-80	189-452-80

CCO PRESCRIPTION ALSO AVAILABLE

BRACKET KITS	ROTH* .022"	EURO (MBT*) .022"
Upper 5-5, Lower 3-3	KIT100-532-00	-
Upper 5-5, Lower 3-3, Hooks on 3	KIT100-532-10	KIT100-532-81
Upper 5-5	KIT100-152-00	-
Upper 5-5, Hooks on 3	KIT100-152-10	KIT100-152-81
Upper 5-5, Lower 3-3, Hooks on 3 L4 & 5 (In-Ovation R)	KIT100-652-10	KIT100-652-81
Upper & Lower 5-5, Hooks on 3 (Zirconia L4 & L5)	KIT100-752-10	-

In-Ovation® C Accessories	Code
In-Ovation C Patient Leaflets, pk 25	120-100-02
In-Ovation C Leaflet Holder	120-100-05
Patient DVD	120-100-06
Marketing Support DVD Set	120-100-07
Consultation Model	TYP100-777-77
Consultation Model - Upper with stand	TYP100-777-00
Engage C-Tool	ODG88008
In-Ovation C & R White Paper	120-089-09

*GAC versions of Roth and MBT prescriptions are not implied to be an exact version of any other system, nor do we claim any endorsement of the Doctors



Ovation® C

Advanced Ceramic Aesthetics

Precision Movement, Predictable Results

The Ovation C bracket is *DENTSPLY GAC*'s most advanced, traditional ceramic bracket. Engineered to deliver precision and control. Ovation C blends in aesthetically with its environment while offering optimal stain resistance. With outstanding durability for a ceramic, Ovation C is strong enough to rebond as needed. All while delivering the predictable results you want, the patient comfort you expect and the aesthetics you demand. It's everything you've come to expect from a *DENTSPLY GAC* bracket.

AESTHETICS

- Translucent ceramic that blends with enamel while resisting stains

STRENGTH

- Durability that defies traditional ceramics, yet strong enough to rebond

PERFORMANCE

- 100% mechanical base for predictable results and easy debonding

Vertical Scribe Line

Provides a visual reference for alignment with the long axis of the clinical crown

Bracket ID System

For quick bracket identification and management before, during and after the procedure

Rhomboid Shape

For better aesthetics during treatment

Smooth Swept Tie-Wings

For hassle-free ligation and enhanced patient comfort

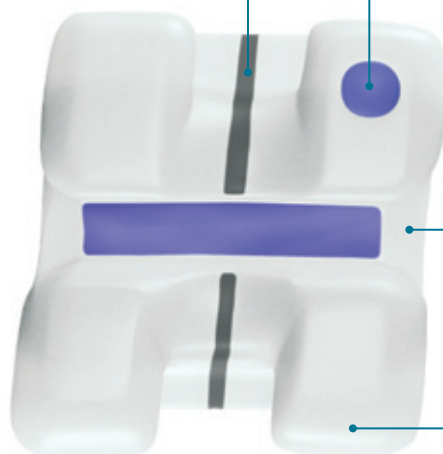

See p66 for aesthetic ligature ties

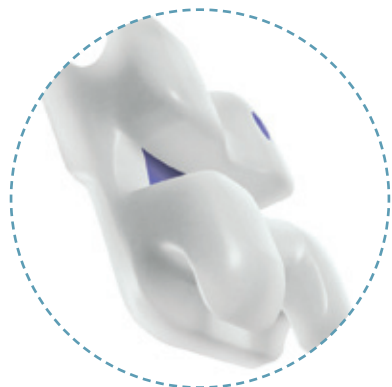

Debonding Indent

For easier debonding this indent along the edge of the bracket provides a positive seat for the debonding instrument



100% Mechanical Base

For reliable bonding and debonding. Unlike other brackets that are designed to crush during debonding, the mechanical base of Ovation C allows for repositioning.

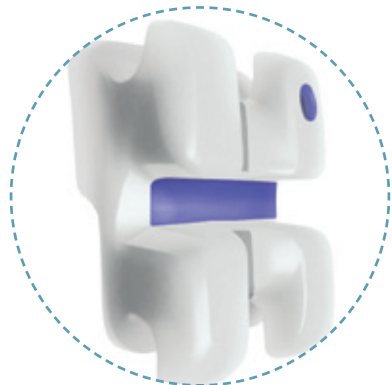

Triple Chamfered Slot Walls

Chamfered slot design for easier engagement, reduced opportunity for archwire binding or crimping and increased inter-bracket span

Hook

As an extension of the distal wing the hook guarantees greater patient comfort and stability



ROTH* .022"	T	A	R	RIGHT	LEFT
U1	12°	5°	0	310-112-00	310-212-00
U2	8°	9°	0	310-122-00	310-222-00
U3	-2°	13°	4m	310-132-00	310-232-00
U3 + Hook	-2°	13°	4m	310-132-10	310-232-10
U4/5	-7°	0°	0	310-542-00	
L1/2	0°	0°	0	310-612-00	
L3	-11°	7°	2m	310-332-00	310-432-00
L3 + Hook	-11°	7°	2m	310-332-10	310-432-10

EURO (MBT*) .022"	T	A	R	RIGHT	LEFT
U1	17°	4°	0	310-112-80	310-212-80
U2	10°	8°	0	310-122-80	310-222-80
U3 + Hook	-7°	8°	0	310-132-81	310-232-81
U4/5	-7°	0°	0	310-542-80	
L1/2	-6°	0°	0	310-612-80	
L3 + Hook	-6°	3°	0	310-332-81	310-432-81

BRACKET KITS	ROTH* .022"	EURO (MBT*) .022"
Upper 5-5, Lower 3-3 + Hooks on 3	K310-531-10	K310-532-80
Upper 5-5 + Hooks on 3	K310-152-10	K310-152-80

*GAC versions of Roth and MBT prescriptions are not implied to be an exact version of any other system, nor do we claim any endorsement of the Doctors

Ghost™

INVISIBLY BRILLIANT

Sapphire Aesthetics with Polycrystalline Strength

Advanced ceramic material for smoother surfaces, superior strength and fracture resistance

Compound contoured base for a precise fit

Triple bevelled slot optimises sliding mechanics and minimises archwire binding

Lower profile design for added patient comfort

Criss-cross mechanical base with uniquely designed undercuts for secure and reliable bonding and trouble-free debonding

Smooth rounded edges providing exceptional patient comfort

Hooks are smooth and rounded for improved patient comfort and secure engagement of elastics

BEAUTY • PERFORMANCE • STRENGTH

A Powerful Combination - Beauty, Performance, Strength

Recent advancements in manufacturing techniques and developments in materials have led to the exciting introduction of our new Ghost bracket. With extraordinary aesthetics, Ghost provides precision and control with superior performance features that can only be achieved with highly sophisticated ceramic injection moulding technology. The result is a truly remarkable bracket system that takes aesthetics, performance and durability to unprecedented heights.



Beauty and Comfort - Unmatched by all other Ceramics

Ghost is as invisible as you can get with a bracket. So much so the brackets allow the natural colour of the tooth to penetrate through providing the most brilliant aesthetic appearance in ceramics today. If beauty and invisibility weren't enough, Ghost delivers greater comfort for the patient as well. The smooth, rounded edges and low profile design combined with anatomically shaped contour of the tie wings minimises soft tissue contact with the bracket to deliver the utmost comfort possible.



Unique Design Mechanical Base

Using a revolutionary manufacturing technique, special undercuts are generated on the bonding surface of the base. These unique undercuts ensure a full mechanical and secure bond. In addition the criss-cross base shape is multi-contoured allowing for a precise fit. Retention is strong and fully mechanical but the bracket debonds reliably without fracturing or damage to the enamel.

You can rest assured that with this unique base the bracket will remain securely bonded throughout the entire treatment.

Exceptional Performance and Strength

Utilising state of the art injection moulding manufacturing means unmatched precision. Ghost is engineered to be strong, reliable and perform to your highest expectations. Injection moulded using a proprietary high-density ceramic material to produce a stronger, denser bracket with a more uniform surface, eliminating the potential for fractures. There is significantly less friction with Ghost brackets - 41% less than conventional sapphire brackets. Lower friction optimises tooth movement and shortens the overall patient treatment time.

ROTH* .022"	T	A	R	RIGHT	LEFT
U1	12°	5°	0	BG-112-00	BG-212-00
U2	8°	9°	0	BG-122-00	BG-222-00
U3	0°	11°	4m	BG-132-00	BG-232-00
U3 + Hook	0°	11°	4m	BG-132-10	BG-232-10
U4/5	-7°	0°	0	BG-142-00	
L1/2	0°	0°	0	BG-312-00	
L3	-11°	5°	2m	BG-332-00	BG-432-00
L3 + Hook	-11°	5°	2m	BG-332-10	BG-432-10
L4	-17°	0°	0	BG-342-00	
L5	-22°	0°	0	BG-352-00	

MBT* .022"	T	A	R	RIGHT	LEFT
U1	17°	4°	0	BG-112-40	BG-212-40
U2	10°	8°	0	BG-122-40	BG-222-40
U3	-7°	8°	0	BG-132-40	BG-232-40
U3 + Hook	-7°	11°	0	BG-132-41	BG-232-41
U4/5	-7°	0°	0	BG-142-40	
L1/2	-6°	0°	0	BG-312-40	
L3	-12°	0°	0	BG-332-40	BG-432-40
L3 + Hook	-12°	0°	0	BG-332-41	BG-432-41
L4	-17°	0°	0	BG-342-40	
L5	-17°	0°	0	BG-352-40	

BRACKET KITS	ROTH* .022"	MBT* .022"
Upper/Lower 5-5	KITBG-055-00	KITBG-055-40
Upper/Lower 5-5 + Hooks	KITBG-055-10	KITBG-055-50
Ghost Consultation Model	BG-TYP-00	

*TOC versions of Roth and MBT prescriptions are not implied to be an exact version of any other system, nor do we claim any endorsement of the Doctors

Verve™ Ceramic

Experience everything Verve has to offer - precision, strength and reliability.

Verve Ceramic are almost invisible as they have the highest translucency, blending naturally with all tooth shades and are highly resistant to staining and discolouration. Verve Ceramic are manufactured from the highest quality polycrystalline alumina providing unmatched strength and durability to minimise bracket fracture. The proven mechanical lock base design ensures optimal bond strength whilst also making debonding predictable and stress free. Clinically proven, Verve Ceramic will deliver exactly what you and your patients are looking for in an aesthetic bracket system.

- Made from the highest quality polycrystalline alumina for strength and durability
- High translucency to blend naturally with all tooth shades
- Resistant to staining and discolouration
- Smooth archwire slot improves sliding mechanics
- Proven mechanical lock base with dove tail grooves for optimal bond strength and predictable debonding

Smooth with rounded edges for improved patient comfort

Smooth archwire slot design improves sliding mechanics

Compound contoured base for the best fit

Removable colour coding for easy identification

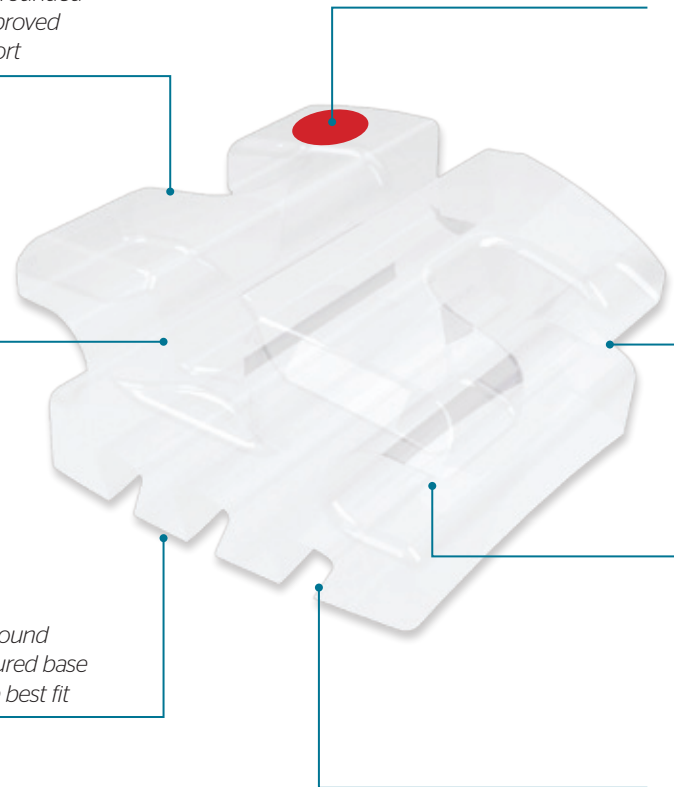

Mechanical lock base with dove tail grooves ensures reliable bonding and predictable debonding



See p51 for Hi-Q Aesthetic wires



BRACKET KITS	ROTH* .022"	MBT* .022"
Upper/Lower 5-5	KITBV-055-20	KITBV-055-40
Upper/Lower 5-5 + Hooks on 3	KITBV-055-23	KITBV-055-43
Upper/Lower 5-5 + Hooks on 3, 4, 5	KITBV-055-25	KITBV-055-45
Upper 5-5 + Hooks on 3	KITBV-055-26	KITBV-055-46
Verve Consultation Model	BV-TYP-00	

TREAT YOUR PATIENTS WITH VERVE!



- Superb aesthetics
- Strength and reliability
- Proven and trusted performance

Generous under tie wing area helps ligation

Low profile design to minimise occlusal interference for added comfort

*T0C versions of Roth and MBT prescriptors are not implied to be an exact version of any other system, nor do we claim any endorsement of the Doctors

ROTH* .022"	T	A	R	RIGHT	LEFT
U1	12°	5°	0	BV-112-00	BV-212-00
U2	8°	9°	0	BV-122-00	BV-222-00
U3	0°	11°	4m	BV-132-00	BV-232-00
U3 + Hook	0°	11°	4m	BV-132-10	BV-232-10
U4/5	-7°	0°	0	BV-542-00	
U4/5 + Hook	-7°	0°	0	BV-542-10	
L1/2	0°	0°	0	BV-612-00	
L3	-11°	5°	2m	BV-332-00	BV-432-00
L3 + Hook	-11°	5°	2m	BV-332-10	BV-432-10
L4	-17°	0°	0	BV-642-00	
L4 + Hook	-17°	0°	0	BV-642-10	
L5	-22°	0°	0	BV-652-00	
L5 + Hook	-22°	0°	0	BV-652-10	

MBT* .022"	T	A	R	RIGHT	LEFT
U1	17°	4°	0	BV-112-40	BV-212-40
U2	8°	9°	0	BV-122-40	BV-222-40
U3	0°	11°	0	BV-132-40	BV-232-40
U3 + Hook	0°	11°	0	BV-132-41	BV-232-41
U4/5	-7°	0°	0	BV-542-40	
U4/5 + Hook	-7°	0°	0	BV-542-41	
L1/2	-6°	0°	0	BV-612-40	
L3	-12°	0°	0	BV-332-40	BV-432-40
L3 + Hook	-11°	5°	0	BV-332-41	BV-432-41
L4	-17°	0°	0	BV-342-40	BV-442-40
L4 + Hook	-17°	0°	0	BV-342-41	BV-442-41
L5	-17°	0°	0	BV-352-40	BV-452-40
L5 + Hook	-17°	0°	0	BV-352-41	BV-452-41

Envy™ Composite Brackets

First choice for value and reliability

Envy is a great alternative to ceramic brackets providing a low cost aesthetic solution for your patients. Highly translucent, Envy blends well with all tooth shades creating a natural appearance and is stain resistant to provide superb aesthetics. Manufactured from the highest quality polyurethane to create a strong bracket resistant to breakage.

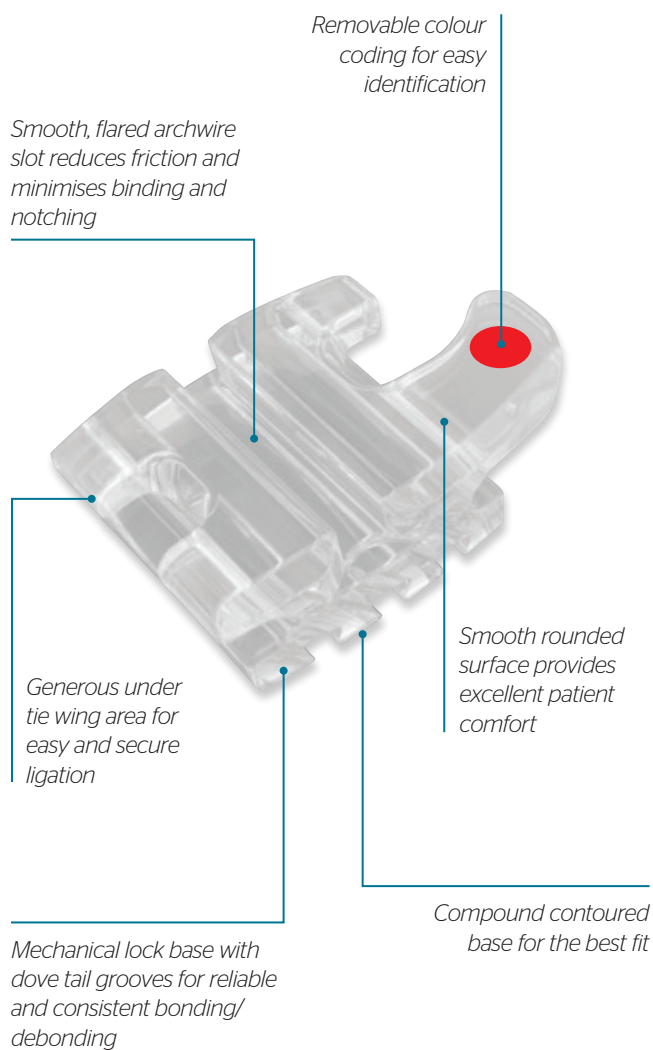

ROTH* .022"	T	A	R	RIGHT	LEFT
U1	12°	5°	0	BE-112-00	BE-212-00
U2	8°	9°	0	BE-122-00	BE-222-00
U3	0°	11°	0	BE-132-00	BE-232-00
U3 + Hook	0°	11°	0	BE-132-10	BE-232-10
U4/5	-7°	0°	0	BE-542-00	
U4/5 + Hook	-7°	0°	0	BE-542-10	
L1/2	0°	0°	0	BE-612-00	
L3	-11°	5°	2m	BE-332-00	BE-432-00
L3 + Hook	-11°	5°	0	BE-332-10	BE-432-10
L4	-17°	0°	0	BE-642-00	
L5	-22°	0°	0	BE-652-00	

MBT* .022"	T	A	R	RIGHT	LEFT
U1	17°	4°	0	BE-112-40	BE-212-40
U2	10°	8°	0	BE-122-40	BE-222-40
U3	-7°	8°	0	BE-132-40	BE-232-40
U3 + Hook	-7°	8°	0	BE-13241	BE-232-41
U4/5	-7°	0°	0	BE-542-40	
U4/5 + Hook	-7°	0°	0	BE-542-41	
L1/2	-6°	0°	0	BE-612-40	
L3	-12°	0°	0	BE-332-40	BE-432-40
L3 + Hook	-12°	0°	0	BE-332-41	BE-432-41
L4	-17°	0°	0	BE-342-40	BE-442-40
L5	-17°	0°	0	BE-352-40	BE-452-40

BRACKET KITS	ROTH* .022"	MBT* .022"
Upper/Lower 5-5	KITBE-055-20	KITBE-055-40
Upper/Lower 5-5 + Hooks on 3	KITBE-055-23	KITBE-055-43
Upper/Lower 5-5 + Hooks on 4 and 5	KITBE-055-25	KITBE-055-45
Envy Consultation Model	BE-TYP-00	

*TOC versions of Roth and MBT prescriptions are not implied to be an exact version of any other system, nor do we claim any endorsement of the Doctors



In-Ovation[®] R

Self-Ligating



In-Ovation[®] mini

Self-Ligating Mini



OmniArch[™]

Premium



Ovation[®]

Premium



VEEVE[™]

Quality



essentials[™]

Value

METAL BRACKET SYSTEMS

In-Ovation® R

Premium Metal Self-Ligating Bracket System

In-Ovation® R Means a Better, Faster Course of Treatment

In-Ovation R is the premium mini twin, self-ligating bracket system that enables you and your staff to treat patients easily - from start to finish - while offering them a faster, more comfortable and attractive treatment option. This unique system enables you to choose whatever technique you prefer while realising predictable results as well as dramatic reductions in chairtime and treatment time.

Better for Orthodontists and Patients

In-Ovation R is easy for orthodontists and staff to use. It delivers superb results, aesthetics and comfort for patients.

The bracket's laser-welded SuperMesh ME base, with its compound contour, promotes ideal placement. Its innovative clip technology easily opens and closes; closing with a nudge of a thumb with an audible "click" to assure correct engagement. An interactive Coballoy spring clip provides better torque expression, while its special fluoride coating ensures easy opening and closing - a full arch change takes seconds!

Shorter Treatment Time

Whichever technique you employ, the In-Ovation R system is designed to provide predictable results and shorter overall treatment times. The bracket's spring clip gently controls rotations throughout treatment, while its true rectangular slot helps deliver precise torque and control. In-Ovation R's reduced twin design provides optimal inter-bracket distance while yielding straight wire results.



DENTSPLY
GAC

An industry leader with well over 1 million patients treated

Smooth Swept Tie Wings

Minimising occlusal interference and increasing patient comfort

Compound Contoured Base

For a precise anatomical fit

Low Profile

For improved comfort

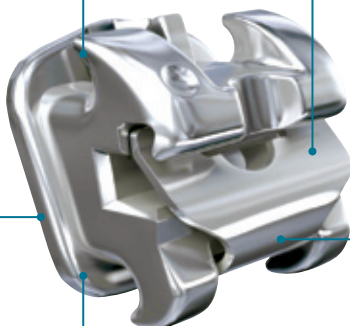

Chamfered Archwire Slot

For facilitating wire engagement and reducing binding

Spring Clip

Provides full slot coverage for true twin rotational control while gently seating the archwire into the base of the slot



Interactive Gives You Control - Start to Finish

In-Ovation R provides you with the ability to start and effectively finish your treatment in one, simple system. Using the technique of your choice, In-Ovation R enables you to maintain the precise degree of control that you need for each phase of your patients' treatment. In-Ovation R's unique Interactive technology means you can choose the degree of engagement between the bracket and wire. In-Ovation R can be passive for levelling and aligning, expressive where control is realised and free-sliding is maintained, or active for fast, optimal finishing. The choice is yours - a benefit not found in "passive only" brackets.

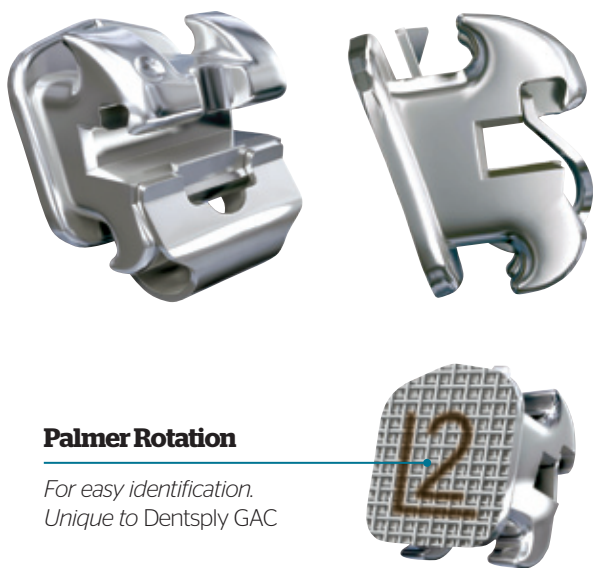

Palmer Rotation

For easy identification.
Unique to Dentsply GAC

In-Ovation R Accessories	Code
In-Ovation R Patient Leaflets, pk 25	120-089-02
Leaflet Holder	20-333-10
In-Ovation Patient DVD	120-089-08
In-Ovation Family DVD	120-222-03
Consultation Model	TYP89-777-77
Consultation Model - Upper with stand	TYP89-777-89
Engage R-Tool	ODG88005
Beaver Tail Instrument	ODG88001
TN3 Bracket Positioning Tool	ODG520
In-Ovation R & C White Paper	120-089-09

BRACKET KITS	ROTH* .022"	EURO (MBT*) .022"
Upper/Lower 5-5	KIT189-055-20	KIT189-552-80
Upper/Lower 5-5, Hooks on 3	KIT189-055-23	KIT189-552-81

ROTH* .022"	T	A	R	RIGHT	LEFT
U1	12°	5°	0	189-112-00	189-212-00
U2	8°	9°	0	189-122-00	189-222-00
U3	-2°	13°	4M	189-132-00	189-232-00
U3 + Hooks	-2°	13°	4M	189-132-10	189-232-10
U3	-2°	10°	4M	189-132-06	189-232-06
U3 + Hooks	-2°	10°	4M	189-132-16	189-232-16
U4/5	-7°	0°	2D	189-142-00	189-242-00
U4/5 + Hooks	-7°	0°	2D	189-142-10	189-242-10
U6 + Hooks S-L	-10°	0°	14D	88-162-05	88-262-05
L1/2	-1°	2°	0	189-312-00	189-412-00
L3	-11°	7°	2M	189-332-00	189-432-00
L3 + Hooks	-11°	7°	2M	189-332-10	189-432-10
L4	-17°	-1°	4D	189-342-00	189-442-00
L4 + Hooks	-17°	-1°	4D	189-342-10	189-442-10
L5	-22°	-1°	4D	189-352-00	189-452-00
L5 + Hooks	-22°	-1°	4D	189-352-10	189-452-10
L6 + Hook S-L	-25°	0°	4D	88-362-09	88-462-09

EURO (MBT*) .022"	T	A	R	RIGHT	LEFT
U1	17°	4°	0	189-112-80	189-212-80
U2	10°	8°	0	189-122-80	189-222-80
U3	-7°	8°	0	189-132-80	189-232-80
U3 + Hooks	-7°	8°	0	189-132-81	189-232-81
U4	-7°	0°	0	189-542-80	
U4 + Hooks	-7°	0°	0	189-142-81	189-242-81
U5	-7°	0°	0	189-552-80	
U5 + Hooks	-7°	0°	0	189-152-81	189-252-81
U6 + Hooks S-L	-14°	0°	0	88-162-81	88-262-81
L1/2	-6°	0°	0	189-612-80	
L3	-6°	3°	0	189-332-80	189-432-80
L3 + Hooks	-6°	3°	0	189-332-81	189-432-81
L4	-12°	2°	0	189-342-80	189-442-80
L4 + Hooks	-12°	2°	0	189-342-81	189-442-81
L5	-17°	2°	0	189-352-80	189-452-80
L5 + Hook	-17°	2°	0	189-352-81	189-452-81
L6 + Hooks S-L	-20°	0°	0	88-362-81	88-462-81

CCO PRESCRIPTION ALSO AVAILABLE

*GAC versions of Roth and MBT prescriptions are not implied to be an exact version of any other system, nor do we claim any endorsement of the Doctors

In-Ovation® Mini

Introducing the tiny bracket with big potential

The new In-Ovation Mini is the smallest self-ligating twin bracket in the In-Ovation range. Designed, developed and manufactured using the latest micro-engineering technology, In-Ovation Mini raises the bar on low-profile performance. From the innovative clip design to the patented interactive technology that offers unmatched precision and control - In-Ovation Mini gives you the power to finish every case with the utmost precision.

Aesthetics and Comfort

With an average profile up to 23% smaller than interactive competitive offerings and embedded pivoting clip, the Mini is raising the bar for low-profile brackets.

New Interactive Clip

The new clip design builds upon *DENTSPLY GAC's* patented interactive technology with additional passive cuspid and bicuspid options. The pivoting clip and facial ledge have been engineered for ease of opening.

Easy to Place

A facial scribe line has been added to the In-Ovation Mini for simplified placement.

Programmed for Versatility

In-Ovation Mini is proud to offer the versatility of both interactive and passive design in a single unified system. It puts unprecedented treatment options in your hands. Passive cuspid and bicuspid are available in the posterior for lower friction sliding mechanics.

True straight wire design

A true straight wire appliance is one in which all the brackets have been designed to guide the teeth into their ideal position with a preformed wire. In-Ovation Mini features a compound contour base, torque in the base, programmed in / out control and level slot alignment.



Base design

An 80 gauge single mesh, compound contoured base provides a precise anatomical fit. The Standard Palmer Notation laser etched into the mesh facilitates bracket management with a ready reference of the quadrant, tooth and prescription.



True Twin Design

Four tie-wings with adequate undercuts and integrated body channel allow easy anchoring of elastic chains or use of colour ties at the patient's request.





Smooth Swept Tie Wings

Helps reduce occlusal interference while increasing patient comfort

Disto-Gingival Dimple

A colour code on the disto-gingival tie-wing provides immediate identification of the tooth for which the bracket was designed

Slot Blocker

Patented Slot Blocker prevents the archwire from escaping the slot

Easy Open Clip

Affords a frustration-free procedure

Triple Chamfered Slot Walls

Ease of engagement, reducing the chance of the archwire binding or crimping

Interactive Spring Clip

Presents the utmost in control throughout treatment

Facial Scribe Line

Added to the In-Ovation Mini for simplified placement

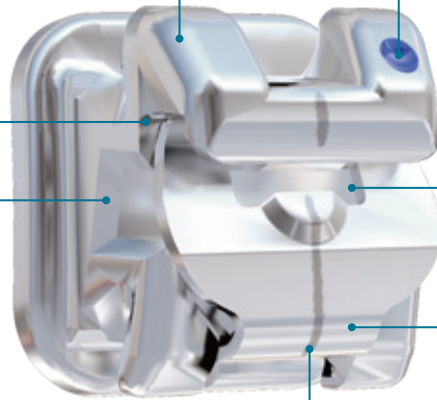

Clip Opening and Closing



Seat the round blade tip of the opening tool onto the projection in the centre of the clip.



Pull the blade tip occlusally to open.



To close gently lift the clip up labially, then push gingivally with fingertip.



Clip in closed position.

BRACKET KITS	ROTH* .022"
Upper/Lower 5-5, Hooks on 3	KIT191-055-23

ROTH* .022"	T	A	R	RIGHT	LEFT
U1	12°	5°	0	191-112-00	191-212-00
U2	8°	9°	0	191-122-00	191-222-00
U3 + Hooks	-2°	13°	4M	191-132-10	191-232-10
U4/5	-7°	0°	2D	191-142-00	191-242-00
L1/2	-1°	2°	0	191-312-00	191-412-00
L3 + Hooks	-11°	7°	2M	189-332-10	189-432-10
L4	-17°	-1°	4D	191-342-00	191-442-00
L5	-22°	-1°	4D	191-352-00	191-452-00

ACCESSORIES	CODE
Mini SL Clip Opener	07-191-101
Mini SL Clip Opener (Pk 5)	07-191-10
Consultation Model	TYP191-777-77
Patient Brochures (Pk 25)	120-191-02



*GAC versions of Roth prescriptions are not implied to be an exact version of any other system, nor do we claim any endorsement of the Doctors

Omni Arch[®]

Premium Twin Metal Bracket System

The Most Advanced Versatile Twin Design

OmniArch is the first mid-sized bracket system that combines all the outstanding elements of the proven twin system with the most advanced bracket design available. Clinicians gain superior control, wedged torque in base and easy bonding. Patients benefit from a bracket that is comfortable, aesthetically pleasing and gives outstanding results. OmniArch is available in a choice of prescriptions and options to suit your treatment goals.

A Bracket System You Can Trust

OmniArch offers efficient and reliable treatment with no accidental debonds. A bracket system you can trust, suitable for both NHS and private patients. Using OmniArch can actually reduce your real treatment costs.

Milled Bracket Manufacturing

The most precise manufacturing process providing complete slot accuracy. Excellent sliding mechanics are guaranteed providing consistent outstanding performance.

Convenient Credit Card Delivery

Designed to save you time and money, OmniArch kits are supplied preloaded onto bracket orientation cards, all ready for bonding.

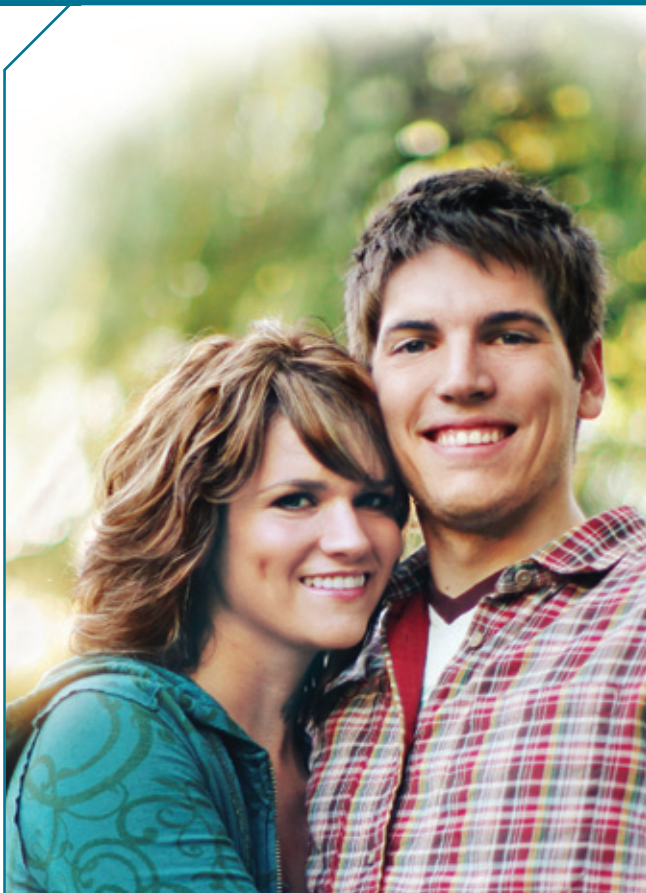

A world wide leader with over 20 years of proven high quality treatments

Mid-Sized & Rhomboid Shaped

For better performance and aesthetics

Wedged Torque

For aligned slots and placement advantages

Low Profile

Provides greater patient comfort

Aligned Angulation

For unequalled mesiodistal / incisogingival orientation

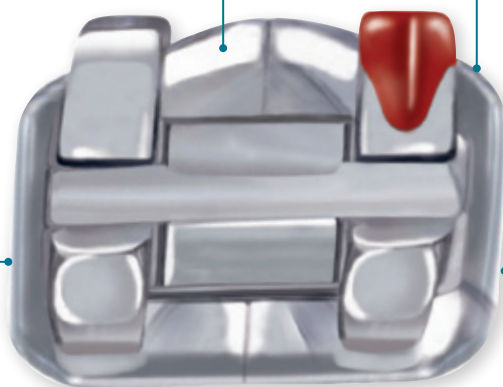



Superior Angulation

- The incisal aspect of OmniArch parallels the tooth's incisal edge, while the tie wings flow with the long, or crown axis. This provides unequalled mesiodistal / incisogingival orientation with precise tipping results.

Low Profile

- Using the latest in materials and research, *Dentsply GAC* has designed OmniArch with significantly lower profile. The design permits earlier bonding, less interference and less soft tissue irritation.



Wedged Torque

- OmniArch's wedged torque provides the aligned slots and placement advantages of torque in the base or diagonal design. It further incorporates an exclusive tie wing design that prevents occlusal interference and the resulting discomfort, bond failure and repositioning.

Size

- OmniArch is the ideal size - small enough to be aesthetically pleasing, yet easy to handle and sized right for greater rotational and torque control not found in mini brackets.

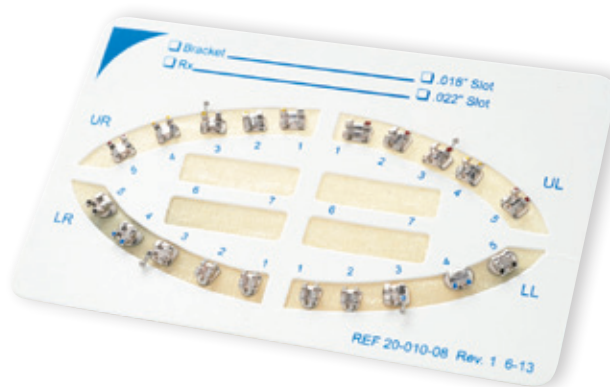

BRACKET KITS	ROTH* .022"	EURO (MBT*) .022"
Upper/Lower 5-5	KIT77-055-20	KIT77-055-60
Upper/Lower 5-5 + Hooks on 3	KIT77-055-23	KIT77-055-61

ROTH* .022"	T	A	R	RIGHT	LEFT
U1	12°	5°	0	77-112-00	77-212-00
U2	8°	9°	0	77-122-00	77-222-00
U3	2°	10°	0	77-132-00	77-232-00
U3 + Hook	2°	10°	0	77-132-10	77-232-10
U4	-7°	0°	0	77-542-00	
U5	-7°	0°	0	77-552-00	
L1/2	-1°	0°	0	77-612-00	
L3	-11°	7°	0	77-332-00	77-432-00
L3 + Hook	-11°	7°	0	77-332-10	77-432-10
L4	-17°	0°	0	77-642-00	
L5	-22°	0°	0	77-652-00	

EURO (MBT*) .022"	T	A	R	RIGHT	LEFT
U1	17°	4°	0	77-112-60	77-212-60
U2	10°	8°	0	77-122-60	77-222-60
U3	-7°	8°	0	77-132-60	77-232-60
U3 + Hook	-7°	8°	0	77-132-61	77-232-61
U4	-7°	0°	0	77-542-60	
U5	-7°	0°	0	77-552-60	
L1/2	-6°	0°	0	77-612-60	
L3	-6°	3°	0	77-332-60	77-432-60
L3 + Hook	-6°	3°	0	77-332-61	77-432-61
L4	-12°	2°	0	77-342-60	77-442-60
L5	-17°	2°	0	77-352-60	77-452-60

*GAC versions of Roth and MBT prescriptions are not implied to be an exact version of any other system, nor do we claim any endorsement of the Doctors

OmniArch[®]

Precision Driven Performance

When it comes to performance, precision and predictability go hand in hand. Manufactured at *DENTSPLY GAC's* new state-of-the-art facility in Sarasota, Florida USA, OmniArch PLUS takes everything you love about the OmniArch system up to the next level.

Re-imagined and rebuilt from the base up, OmniArch PLUS pushes the limits of precision to deliver the ultimate in performance.

- Small enough for the aesthetic conscious patient
- Large enough for efficient usability
- Integrated ball hook for stability and malleability
- Triple chamfered slot for easy wire placement
- 80 gauge mesh base for predictable bonding and debonding

DENTSPLY
GAC

Disto-Gingival ID

For easy identification

Mid-Size Low Profile Twin

Ideal working size

Torque In Base

For level slot alignment

Compound Contour Base

For a precise anatomical fit

Smooth Swept Tie-Wings

Helps reduce occlusal interference and improves patient comfort

Rhomboid Shape

Aids placement

True Twin Design

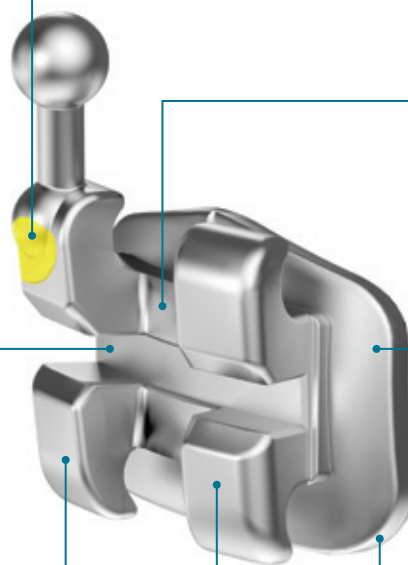



MIM (Metal Injection Moulded) Design

Delivers 50% increase in accuracy of torque and 33% in offset for greater consistency, accuracy and precision

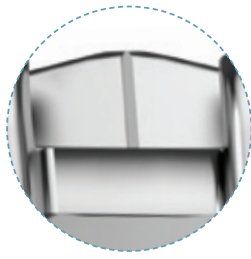

Centre Scribe Line

Provides a visual reference for alignment with the long axis of the clinical crown



80 Gauge Mesh Design

80 gauge single mesh, compound contoured base engineered for a precise anatomical fit

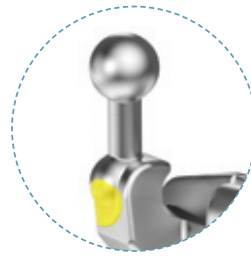

Integrated Ball Hook Design

Enhanced design consistency while maintaining the essential functionality, such as malleability and strength

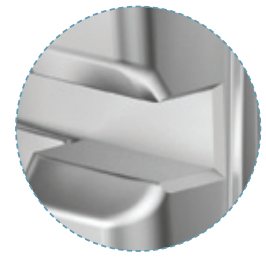

Triple Chamfered Slot Walls

Easy engagement, designed to reduce the chance of the archwire binding or crimping

- Metal injection moulded for the ultimate in production consistency
- Fine-tuned offset and torque for enhanced control
- Unique polishing process for a smooth, comfortable finish
- Welded base body for stability and precision
- Digitally engineered tie-wings for outstanding workability

ENGINEERING SUCCESS

It's all but impossible to improve upon an industry standard like OmniArch without a good idea of what you want to accomplish. Every design enhancement to OmniArch PLUS was subjected to an exhaustive explorative process. Each idea was tested, refined and then tested again. Nothing was considered complete until it met or exceeded *DENTSPLY GAC's* exacting standards.

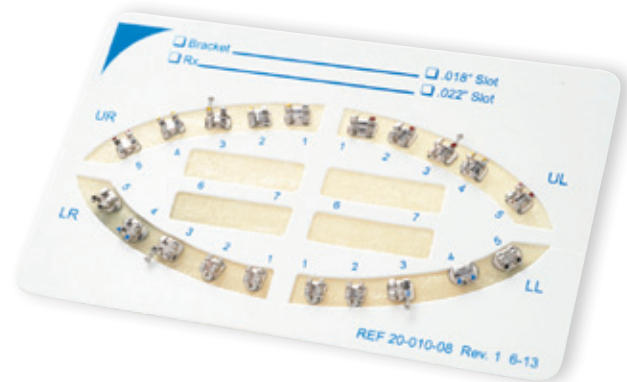

BRACKET KITS	ROTH* .022"	EURO (MBT*) .022"
Upper/Lower 5-5 + Hooks on 3	KJ77-055-23	KJ77-055-61

ROTH* .022"	T	A	RIGHT	LEFT
U1	12°	5°	J77-112-00	J77-212-00
U2	8°	9°	J77-122-00	J77-222-00
U3 + Hook	2°	10°	J77-132-10	J77-232-10
U4	-7°	0°	J77-542-00	
U5	-7°	0°	J77-552-00	
L1/2	-1°	0°	J77-612-00	
L3 + Hook	-11°	7°	J77-332-10	J77-432-10
L4	-17°	0°	J77-642-00	
L5	-22°	0°	J77-652-00	

EURO (MBT*) .022"	T	A	RIGHT	LEFT
U1	17°	4°	J77-112-60	J77-212-60
U2	10°	8°	J77-122-60	J77-222-60
U3 + Hook	-7°	8°	J77-132-61	J77-232-61
U4	-7°	0°	J77-542-60	
U5	-7°	0°	J77-552-60	
L1/2	-6°	0°	J77-612-60	
L3 + Hook	-6°	3°	J77-332-61	J77-432-61
L4	-12°	2°	J77-342-60	J77-442-60
L5	-17°	2°	J77-352-60	J77-452-60

*GAC versions of Roth and MBT prescriptions are not implied to be an exact version of any other system, nor do we claim any endorsement of the Doctors

Ovation[®]

Premium Metal Bracket System

All the advantages in one bracket

Ovation is completely programmed and is a four dimensional bracket that combines Metal Injection Moulding (MIM) and Computer Numerator Controlled Milling (CNC). MIM allows for smaller design with greater strength and full compound contouring of the bases, whilst the CNC milling ensures a highly consistent and accurate slot.

Ideal Size

Ovation's slightly larger size makes this bracket ideal for teaching. It's the dental hospitals' first choice for robust predictable performance.

Convenient Credit Card Delivery

Designed to save you time and money, Ovation kits are supplied preloaded onto bracket orientation cards, all ready for bonding.

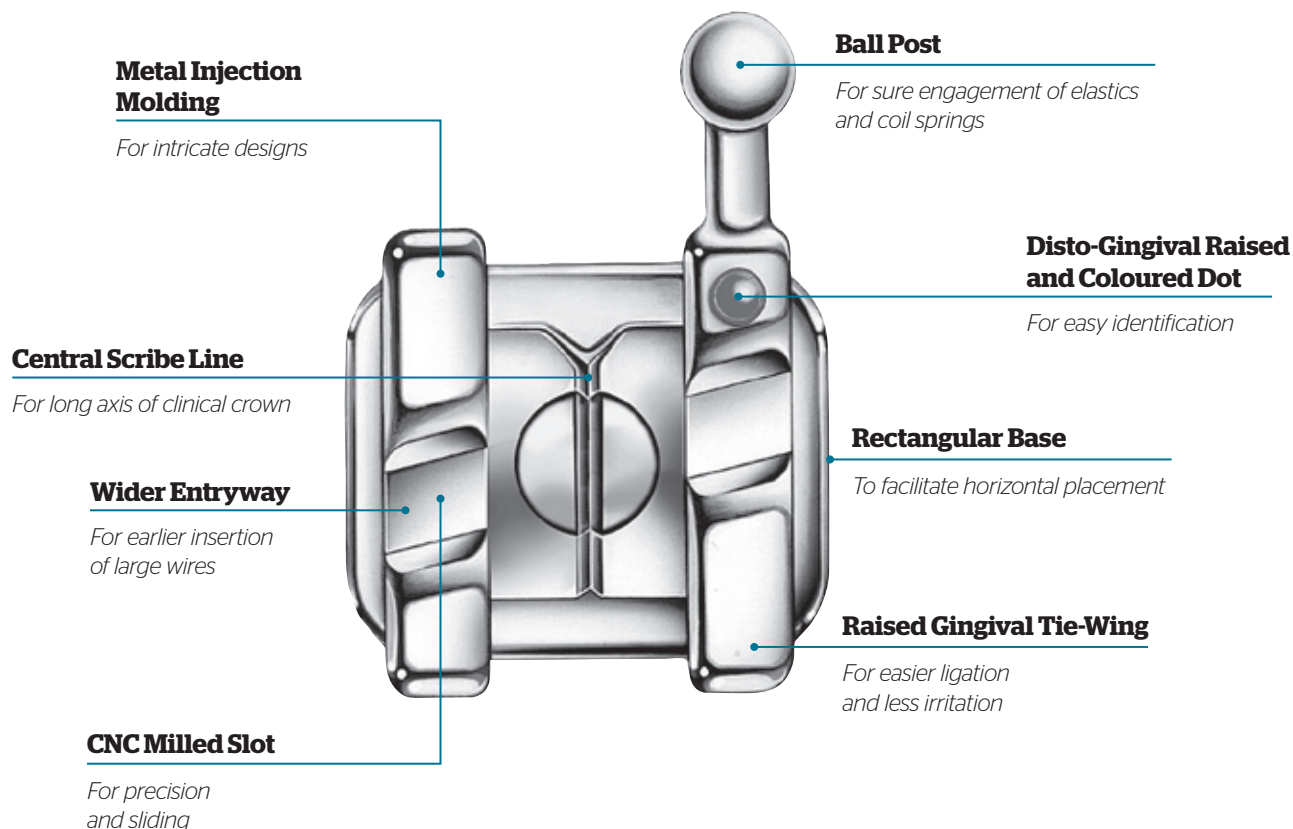

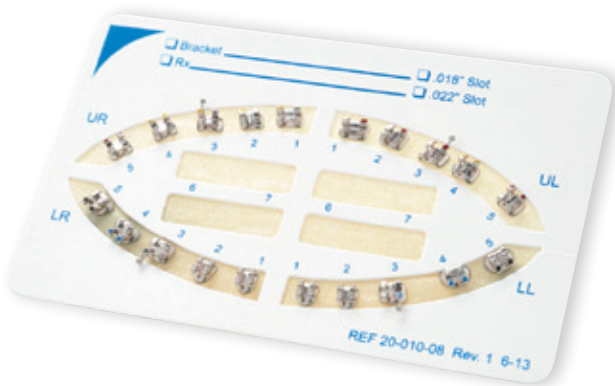
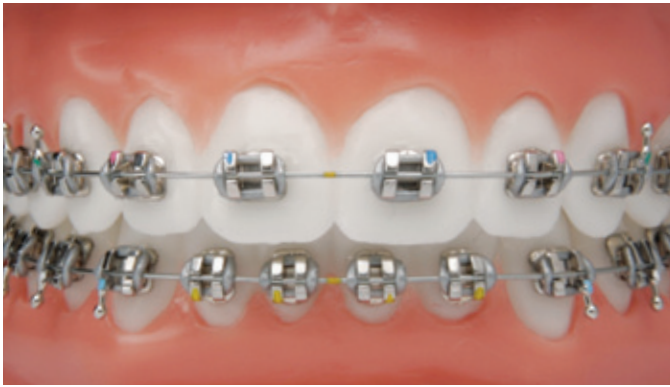

BRACKET KITS	ROTH*.022"
Upper/Lower 5-5	KIT82-055-20
Upper/Lower 5-5 + Hooks on 3	KIT82-055-23

ROTH*.022"	T	A	R	RIGHT	LEFT
U1	12°	5°	0	82-112-00	82-212-00
U2	8°	9°	0	82-122-00	82-222-00
U3	-2°	13°	4M	82-132-00	82-232-00
U3 Surgical Rx	-2°	9°	4M	82-132-06	82-232-06
U3 + Hook	-2°	13°	4M	82-132-10	82-232-10
U3 + Hook Surgical Rx	-2°	9°	4M	82-132-16	82-232-16
U4/5	-7°	0°	2D	82-142-00	82-242-00
U4/5 + Hook	-7°	0°	2D	82-142-10	82-242-10
L1/2	-1°	2°	0	82-312-00	82-412-00
L3	-11°	7°	2M	82-332-00	82-432-00
L3 + Hook	-11°	7°	2M	82-332-10	82-432-10
L4	-17°	-1°	4D	82-342-00	82-442-00
L4 + Hook	-17°	-1°	4D	82-342-10	82-442-10
L5	-22°	-1°	4D	82-352-00	82-452-00
L5 + Hook	-22°	-1°	4D	82-352-10	82-452-10

A favourite of teaching hospitals



Verve™

Precision, strength and reliability

Verve is precision engineered to a design that fulfils all your expectations of a high quality bracket. Created to provide great strength and reliability, with features that will allow you to treat with confidence. Now you can really enjoy using Verve and your patients will love them!

Precision Engineered

Verve has an advanced design that combines Metal Injection Moulding (MIM) and Computer Numerator Controlled Milling (CNC). MIM allows for a smaller and more detailed design which has greater strength whilst the CNC milling provides the most accurate of slots for advanced sliding mechanics.

Ease of Use

Verve incorporates many features to help with bracket placement, bonding and ligation of elastomers; the compound contoured Super-Grip™ base means there is no need to worry about accidental debonds.

Bracket options include bicuspid with an offset base making it easier to bond partially erupted teeth while still providing straight wire mechanics. The additional option of an extended bonding pad on pre-molars means the brackets are easier to position as it allows the bracket slot and more of the base to be visible during bonding. Bond strength is also increased with these bases. Bracket kits are conveniently supplied pre-loaded onto bracket orientation cards ready for bonding to save you both time and money.

Treatment Results

Verve provides you with efficient and predictable treatment case after case, with true torque in the base delivering exact bracket prescription values, accurate slots and in / out dimensions with fewer wire bends. Your patients will appreciate the comfort, look and the results too!



- CNC milled slot for greater precision and more efficient treatment
- Offset and extended base options to suit your specific requirements
- Compound contouring facilitates placement
- Low profile minimises occlusal interferences
- Palladium alloy brazing for the strongest bracket-to-base bond
- Mushroom shaped hook secures chains and ligatures in place without slipping
- Torque in base for level slot alignment

Highly visible vertical scribe line for quick and precise placement

Super polished low friction slot for great sliding mechanics

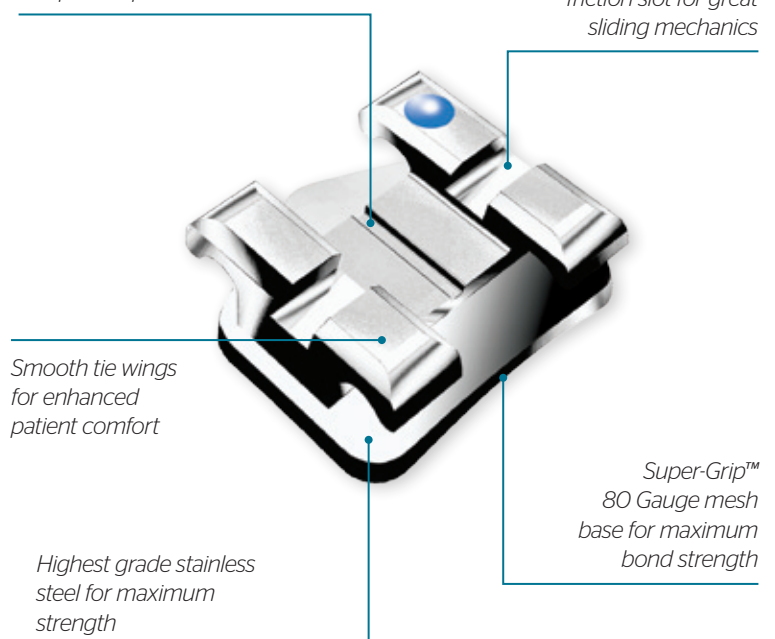

Smooth tie wings for enhanced patient comfort

Highest grade stainless steel for maximum strength

Super-Grip™ 80 Gauge mesh base for maximum bond strength

Bi-directional canine hook is rounded and smooth for patient comfort

Permanent ID by quadrant with removable colour coding

Chamfered tie wings for ease of ligature placement



See p35 & 38 for Verve Buccal Tubes and Bands

TREAT YOUR PATIENTS WITH VERVE!

- Guaranteed ease of use
- Treatment efficiency
- Predictable results



ROTH* .022"	T	A	R	RIGHT	LEFT
U1	12°	5°	0	AV-112-00	AV-212-00
U2	8°	9°	0	AV-122-00	AV-222-00
U3	0°	11°	4M	AV-132-00	AV-232-00
U3 + Hook	0°	11°	4M	AV-132-10	AV-232-10
U4	-7°	0°	0	AV-142-00	AV-242-00
U4 Offset	-7°	0°	0	AV-142-13	AV-242-13
U4 Offset + Extended Base	-7°	0°	0	AV-142-15	AV-242-15
U5	-7°	0°	0	AV-152-00	AV-252-00
U5 Offset	-7°	0°	0	AV-152-13	AV-252-13
U5 Offset + Extended Base	-7°	0°	0	AV-152-15	AV-252-15
L1/2	0°	0°	0	AV-312-00	AV-412-00
L3	-22°	-1°	4D	AV-332-00	AV-432-00
L3 + Hook	-22°	-1°	4D	AV-332-10	AV-432-10
L4	-17°	0°	0	AV-342-00	AV-442-00
L4 Offset	-17°	0°	0	AV-342-13	AV-442-13
L4 Offset + Extended Base	-17°	0°	0	AV-342-15	AV-442-15
L5	-22°	0°	0	AV-352-00	AV-452-00
L5 Offset	-22°	0°	0	AV-352-13	AV-452-13
L5 Offset + Extended Base	-22°	0°	0	AV-352-15	AV-452-15

BRACKET KITS	ROTH* .022"
Upper/Lower 5-5	KITAV-055-00
Upper/Lower 5-5 Offset	KITAV-055-03
Upper/Lower 5-5 + Extended Base	KITAV-055-05
Upper 5-5 + Hooks on 3	KITAV-055-10
Upper 5-5 + Hooks on 3, Offset	KITAV-055-13
Upper/Lower 5-5 + Hooks on 3 Offset Extended Base	KITAV-055-15

MBT* .022"	T	A	R	RIGHT	LEFT
U1	17°	4°	0	AV-112-40	AV-212-40
U2	10°	8°	0	AV-122-40	AV-222-40
U3	0°	9°	0	AV-132-40	AV-232-40
U3 + Hook	0°	9°	0	AV-132-41	AV-232-41
U4	-7°	0°	0	AV-142-40	AV-242-40
U4 Offset	-7°	0°	0	AV-142-43	AV-242-43
U4 Offset + Extended Base	-7°	0°	0	AV-142-45	AV-242-45
U5	-7°	0°	0	AV-152-40	AV-252-40
U5 Offset	-7°	0°	0	AV-152-43	AV-252-43
U5 Offset + Extended Base	-7°	0°	0	AV-152-45	AV-252-45
L1/2	-6°	0°	0	AV-312-40	AV-412-40
L3	-6°	3°	0	AV-332-40	AV-432-40
L3 + Hook	-6°	3°	0	AV-332-41	AV-432-41
L4	-12°	2°	0	AV-342-40	AV-442-40
L4 Offset	-12°	2°	0	AV-342-43	AV-442-43
L4 Offset + Extended Base	-12°	2°	0	AV-342-45	AV-442-45
L5	-17°	2°	0	AV-352-40	AV-452-40
L5 Offset	-17°	2°	0	AV-352-43	AV-452-43
L5 Offset + Extended Base	-17°	2°	0	AV-352-45	AV-452-45

BRACKET KITS	MBT* .022"
Upper/Lower 5-5	KITAV-055-40
Upper/Lower 5-5 Offset	KITAV-055-43
Upper/Lower 5-5 + Extended Base	KITAV-055-45
Upper 5-5 + Hooks on 3	KITAV-055-50
Upper 5-5 + Hooks on 3, Offset	KITAV-055-53
Upper/Lower 5-5 + Hooks on 3 Offset Extended Base	KITAV-055-55

*TOC versions of Roth and MBT prescriptions are not implied to be an exact version of any other system, nor do we claim any endorsement of the Doctors

Essentials™

Value Stainless Steel Bracket System

Manufactured from advanced 17-4 stainless steel, Essentials brackets offer maximum strength and reliability in performance. Stay in control of your consumable costs by using Essentials.

- **Chamfered Slot Design**
Makes wire insertion easier
- **Ultra Smooth Slot**
For reduced friction and shorter treatment time
- **Rounded Ball Hooks**
Helps improve patient comfort
- **Low Profile**
For added patient comfort
- **Proven 80 Gauge Mesh Base**
For reliable and predictable bonding
- **Centre Scribe Line**
Makes for easy and accurate placement
- **Smooth, Rounded Corners**
Means less tissue irritation



See
p36 & 38
for Essentials
Buccal Tubes
and Bands



We preload your brackets on orientation cards for you at no extra cost

ROTH* .022"	T	A	R	RIGHT	LEFT
U1	12°	5°	0	AE-112-00	AE-212-00
U2	8°	9°	0	AE-122-00	AE-222-00
U3	0°	11°	4M	AE-132-00	AE-232-00
U3 + Hook	0°	11°	4M	AE-132-10	AE-232-10
U4	-7°	0°	0	AE-542-00	
U5	-7°	0°	0	AE-552-00	
L1/2	0°	0°	0	AE-312-00	AE-412-00
L3	-11°	5°	0	AV-332-00	AV-432-00
L3 + Hook	-11°	5°	0	AE-332-10	AE-432-10
L4	-17°	0°	0	AE-642-00	
L5	-22°	0°	0	AE-652-00	

MBT* .022"	T	A	R	RIGHT	LEFT
U1	12°	5°	0	AE-112-40	AE-212-40
U2	8°	9°	0	AE-122-40	AE-222-40
U3	0°	11°	4M	AE-132-40	AE-232-40
U3 + Hook	0°	11°	4M	AE-132-41	AE-232-41
U4/5	-7°	0°	0	AE-142-40	AE-242-40
L1/2	0°	0°	0	AE-312-40	AE-412-40
L3	-11°	5°	0	AE-332-40	AE-432-40
L3 + Hook	-11°	5°	0	AE-332-41	AE-432-41
L4	-17°	0°	0	AE-342-40	AE-442-40
L5	-22°	0°	0	AE-352-40	AE-452-40

BRACKET KITS	ROTH* .022"	MBT* .022"
Upper/Lower 5-5	KITAE-055-00	KITAE-055-40
Upper 5-5 + Hooks on 3	KITAE-055-10	KITAE-055-50

*TOC versions of Roth and MBT prescriptions are not implied to be an exact version of any other system, nor do we claim any endorsement of the Doctors

**Interactive
In-Ovation:
The system
that gives you
control**



Minor Tooth
Movement



Full Lingual

LINGUAL BRACKET SYSTEMS



MTM[®] No Trace[™]

Lingual Self-Ligating Bracket System
for Minor Tooth Movement

For the Fast Correction of Minor Anterior Misalignments

For so many patients the difference between an ordinary and a radiant smile can be measured in only a few millimetres. With the introduction of MTM No Trace, achieving that smile can now also be realised in weeks instead of months or years.

Quick Cosmetic Correction

A beautiful smile results from the aesthetic alignment of the six upper and six lower anterior teeth. MTM No Trace turns these into a "dazzling dozen" using a system of "quick clips" - unprecedentedly tiny, self-ligating lingual brackets that bond just below the incisal edge. MTM No Trace may be bonded directly or indirectly, both allowing the brackets to be positioned and bonded quickly; the self-ligating clip allows the wire to be seated and secured in seconds.

For cases requiring tooth movement of 6mm or less, MTM No Trace achieves results that compare favourably with those of the popular aligner systems - but does so in approximately 12 to 24 weeks. This makes MTM No Trace ideal for patients who desire fast results with a truly invisible appliance. With MTM No Trace they can acquire a beautiful smile in no time!

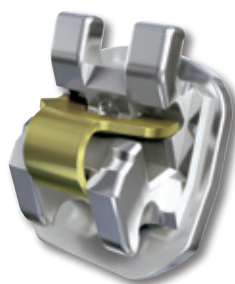

A BREAKTHROUGH IN COSMETIC ORTHODONTICS...

- Fast correction for minor anterior misalignments
- New treatment options - new patients
- Fast, easy direct or indirect bonding
- Ease of self-ligation
- Eliminates virtually all patient compliance issues
- Minimal wire changes for reduced chair time

CLINICAL INDICATIONS

MTM is appropriate for patients with the following:

- Crowding of 6mm or less
- Spacing of 3mm or less / Midline correction of 2mm or less
- Rotations of 25 degrees or less



INVISIBLE ORTHODONTICS WITH YOU IN CONTROL

FOR YOUR PATIENTS

- Absolutely undetectable
- Small, low profile brackets for maximum comfort
- Fast results in a matter of weeks
- Fewer practice visits

FOR YOU

- Additional source of revenue
- Fast, easy placement with direct or optional indirect bonding
- Rapid wire engagement with self-ligating brackets
- Virtually eliminates patient compliance issues
- You control the treatment

DENSPLY
GAC



Case Study



Pre-treatment



Initial placement



Final treatment time: 12 weeks

tenvis™

See p127 for our specially designed Tenvis™ Lingual instruments that help make lingual treatment easier.

BRACKET KITS	.018" Slot
Upper/Lower 4-4	KIT90-055-00
Upper 4-4	KIT90-141-00
Upper 3-3	KIT90-055-01
Lower 4-4	KIT90-055-04
Lower 3-3	KIT90-055-02

SINGLE BRACKETS	T	A	R/L	.018" Slot
U1/2/3	60°	0°	U	190-511-90
L1/2/3	50°	0°	U	190-611-90
U/L4	10°	0°	U	190-751-00

MTM No Trace Accessories	Code
MTM No Trace Patient Leaflets pk 25	120-090-04
MTM No Trace Instructional DVD	120-090-06
MTM No Trace Patient DVD pk 25	120-090-08
MTM No Trace Wall Poster	120-090-07
Digital Display	120-344-02
Consultation Model	TYP90-777-90
Mini Scaler	GAC890
Lingual You Will Love White Paper	120-090-09
Tennis Lingual Wire Placer	TEN100LG

GET STARTED WITH MTM NO TRACE

INTRO KIT: KIT90-055-99

CLINICAL

- 5 kits MTM No Trace Brackets U/L 4-4
- Bracket Placement Instrument
- Mini Scaler/Clip Opener

MARKETING

- 50 MTM No Trace patient brochures
- 25 Patient DVDs
- 1 MTM No Trace Consultation model
- MTM No Trace poster

WELCOME KIT: KIT90-055-90

CLINICAL

- 10 kits MTM No Trace Brackets U/L 4-4
- Bracket Placement Instrument
- Mini Scaler/Clip Opener
- Tennis Cinch Back Pliers
- Tennis Lingual Wire Placer
- 20 x Sentalloy Mushroom Archwires
- Lingual Arch Form Template
- NeoBond® Adhesive Intro Kit with NeoBand® Occlusal Build Up

MARKETING

- 7" Digital Frame Display
- 50 MTM No Trace patient brochures
- 25 Patient DVDs
- 1 MTM No Trace Consultation model
- MTM No Trace poster

In-Ovation® L

Full Lingual Self-Ligating Bracket System

Unprecedented Ease of Use

In-Ovation L self-ligating brackets solve one of the biggest problems orthodontists have traditionally encountered with lingual systems - archwire ligation. The In-Ovation L clip opens and closes easily and quickly to make archwire ligation literally a "snap". In contrast to treatment with some retainer systems, In-Ovation L is under your control and treatment philosophy, not the control of a remote computer. For an appliance that is more undetectable than aligner systems, consider the truly aesthetic appliance system, In-Ovation L, available exclusively from TOC.



Experience the Difference with In-Ovation L

DENTSPLY GAC has translated the proven clinical benefits of In-Ovation R into a lingual design. Only an interactive bracket provides full functionality throughout the course of treatment. This allows you to enjoy the early benefits of a free-sliding, passive design and the precise control of an active one in the later stages of treatment. In-Ovation L gives you a complete range of control options... simply by changing the archwire.



LEADING THE WAY IN LINGUAL BRACKETS

- Fast and easy lingual wire changes
- Interactive design for precise, selective control
- Low profile for greater patient comfort and avoiding gingival interference
- Superior sliding mechanics
- True twin design
- Anatomically correct base design
- Metal injection moulded (MIM) for small size and greater strength
- CNC milled for true slot dimensions and smooth finish

BRACKETS	T	A	R/L	.018" Slot
U1/2	60°	0°	U	190-511-00
U3	60°	0°	U	190-531-00
U3 + Hook	60°	0°	U	190-531-10
U4/5	10°	0°	U	190-751-00
U6/7	10°	0°	R	190-161-10
			L	190-261-10
L1/2	50°	0°	U	190-611-00
L3	50°	0°	U	190-631-00
L4/5	10°	0°	U	190-751-00
L6/7	0°	0°	R	190-361-10
			L	190-461-10

KIT DESCRIPTION	.018" Slot
Upper/Lower 7-7	KIT90-055-10
Upper 7-7	KIT90-151-10
Lower 7-7	KIT90-251-10

IN-OVATION L ACCESSORIES	Code
Consultation Model	TYP90-777-77
Mini Scaler	GAC890
Tennis Lingual Wire Placer	TENI00LG





Premium



Quality



Value

MOLAR BANDS & BUCCAL TUBES

Snap-Fit™ Molar Bands

Premium Quality Prewelded Bands

Selecting the proper orthodontic band is crucial in the corrective process. The criteria for selecting the right band can include ease and accuracy of placement, elasticity and how the band contours to the anatomy of the tooth. In addition to a brilliant, hand-polished finish, DENTSPLY GAC bands have either acid-etch or micro-etched properties that enhance retention to the tooth. These bands also have a convenient labelling system that is laser-etched onto the surface.

Our Snap-Fit Molar Bands offer greater elasticity and superior fit. DENTSPLY GAC's exclusive process produces bands with improved morphology, elasticity and memory. Snap-Fit bands are created with high contouring and snap right into place when the right size is implemented. You simply press on the disto-lingual and then the mesio-labial and the band 'snaps' into place. After fitting and removal, the band returns to its original size, assuring that the cemented band is as accurate as the initial fit.

Snap-Fit Molar Bands are offered in graduated, proportional sizes, maxillary and mandibular, left and right (32 sizes for first molars, 30 sizes for second molars). Snap-Fit Molar Bands are available plain or pre-welded.

Snap-Fit are the choice of many leading orthodontists world wide. A quarter of a century of experience has proven that they can dramatically reduce your loose band rate if properly sized. It's no wonder that Snap-Fit bands have been well accepted by thousands of clinicians across the world.

All Snap-Fit bands are marked using our patented Electro Chemical Etching process for easy-to-read permanent identification, and interiors are micro-etched for roughness to increase bond strength.

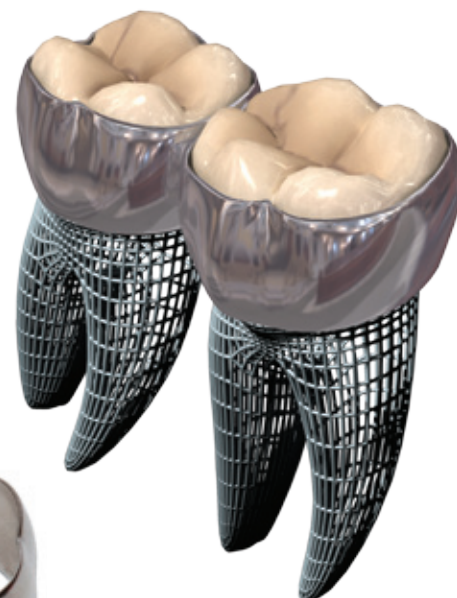

Buccal Tubes & attachments prewelded FREE!

Second Molar & Bicuspid Bands also available

- **Guaranteed Weld Strength**
For extra peace of mind
- **Micro-Etched Interiors**
To increase bond strength
- **Electro-Chemically Etched**
Sizes for easy identification
- **Polished Exteriors**
For maximum patient comfort

Stock Snap-Fit Bands below with our most popular attachments. Other attachments available.



.022"	Slot Torque	Offset	Prewelded Right	Prewelded Left
Upper	-10°	7D	69-162-09	69-262-09
Lower	-25°	4D	69-362-09	69-462-09

.022"	Slot Torque	Offset	Prewelded Right	Prewelded Left
Upper	-14°	14D	69-172-05	69-272-05
Lower	-25°	6D	69-372-05	69-472-05

Verve™

Prewelded Molar Bands

Precision Shaped for a Tight, Secure Fit

Each band is precisely shaped to fit each tooth securely with excellent retention

Hard but Malleable Stainless Steel

Strong enough to avoid wall collapse when fitting, yet is malleable enough for 'snap' fitting that requires little or no burnishing

Increased Buccal Height

For greater flexibility in placement and positioning of buccal tubes and lingual attachments

Micro-Etched Interiors

Provides a rough surface for increased bond strength

Permanently Etched Exterior

For easy identification

Anatomically Contoured

Fast placement and accurate fit

Permanent Marking

For easy identification

Straight Interproximal Wall

Makes band seating easy

1st & 2nd Molar Bands available



Upper Combination Convertible with or without Lingual Cleats



Upper Single Convertible with or without Lingual Cleats



Lower Single Convertible with or without Lingual Cleats

Rolled Edges

No sharp edges, maximum patient comfort

Ideally Tempered

For easy contouring

Micro-Etched Interior Surface

Ensures maximum retention

Comparable 3M Unitek sizes

Band Conversion chart available

Sizes available from 29.5 to 44

ROTH*	Slot Torque	Distal Offset
.022" Upper	-10°	8°
.022" Lower	-25°	5°

MBT*	Slot Torque	Distal Offset
.022" Upper	-14°	10°
.022" Lower	-20°	0°

*The TOC versions of these prescriptions are not implied to be an exact version of any other system nor do we claim any endorsement of the doctors.

essentials™

Value 1st Molar Prewelded Bands

- Micro-etched interiors increases bond strength and retention
- Rolled edges for maximum patient comfort
- Anatomically contoured for quick placement and an accurate fit
- Permanent marking system for easy identification
- Ideally tempered allows easy contouring
- Straight interproximal wall makes band seating easy



1st Molar Band .022"	Sizes	Right	Left
Upper	29.5-44	ME-***-15+	ME-***-25+
Lower	29.5-44	ME-***-35+	ME-***-45+

Single Non-Convertible MBT* .022"
 Sizes available from 29.5 to 44

Bracket & Band Storage



- Suitable for Verve and Essentials Bands
- Modular interlocking design
- Quickly locate exactly what you need with the clearly marked trays
- Constructed with high quality durable plastic
- Organiser dimensions: 11 ¼" W x 1 ½" H x 8 ¼" D



Includes:

Band/bracket tray and 1 "drawer"

Product	Code
Band Organiser	85180K
Bracket Organiser	85181K

Product	Code
UR 1st/2nd Molar Band Tray	4002-05
UL 1st/2nd Molar Band Tray	4002-06
LR 1st/2nd Molar Band Tray	4002-07
LL 1st/2nd Molar Band Tray	4002-08

*The TOC versions of these prescriptions are not implied to be an exact version of any other system nor do we claim any endorsement of the doctors.



Premium Bondable Buccal Tubes

Macro Low Profile Buccal Tube

Reduce your bond failures with this next generation of low profile bondable buccal tubes. The Macro tube is a shorter tube with a wider opening designed especially for lower first and second molars. For highly rotated molars, the Macro tube offers a 50% wider opening at the mesial, built into the convertible cap. The cap has 50% greater weld strength at the mesial that helps avoid accidental conversion when placing large wires. If the rotation is severe, you can use a converter to lift off the cap without major discomfort to the patient. In addition, the design of the occlusal wings keeps them out of occlusion, often a major problem with bondable tubes.

The elongated base which is notched at the ideal placement point is specially designed to hug the buccal surface of the tooth for perfect positioning and reduced bond failure. The base is also sandblasted for enhanced bond strength.



- Low profile for maximum comfort
- 50% wider opening for easier wire insertion
- Easy placement
- Enhanced bond strength
- Reduced bond failures



.022"	Slot Torque	Offset	Right	Left
Upper	-10°	14D	68-162-35	68-262-35
Lower	-10°	0	68-362-32	68-462-32

Product	Code
Tube Converter	KIT97-999-40
Replacement Tip	T871A/6

Non-Convertible Single Tubes

This non-convertible single tube complements the Roth technique. The hook is mesio-lingual and the tube has a dimple to facilitate positioning with a placer. The span is 4.0mm.

Smooth Contour and Low Profile

For improved patient comfort

Round Ball Hooks

For protecting soft tissue and patient comfort

Dimple

For easier placement

Micro Etched Base

For greater consistency

Wider Entry Way

For easier wire insertion

Wider Span

For greater bond strength

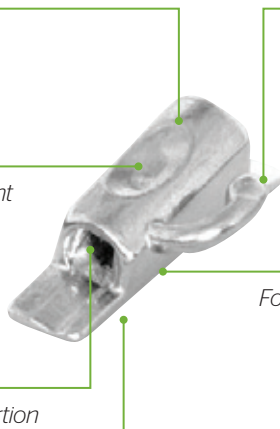

.022"	Slot Torque	Offset	Right	Left
Upper	-14°	14D	68-172-05	68-272-05
Lower	-25°	6D	68-372-05	68-472-05

In-Ovation Self-Ligating Tubes

Easy archwire placement and quick snap closure

In-Ovation's new SL buccal tubes present convenient, easy access to archwires and quick fingertip closure. Their natural anatomical fit, low profile and ultra-smooth metal injection moulded (MIM) construction enhances patient comfort. Their full-length design holds more wire to realise better, more effective rotation and exceptional performance.

In-Ovation SL Buccal Tubes close with only light fingertip pressure. An audible click provides peace of mind that the clip is closed.

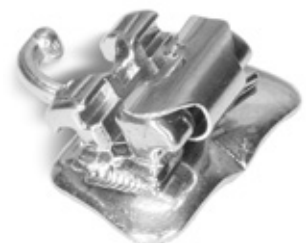

Roth* .022"	Slot Torque	Offset	Right	Left
Upper	-10°	14D	88-162-05	88-262-05
Lower	-25°	4D	88-362-09	88-462-09

Euro (MBT*) .022"	Slot Torque	Offset	Right	Left
Upper	-14°	10	88-162-81	88-262-81
Lower	-20°	0	88-362-81	88-462-81

*GAC versions of Roth and MBT prescriptions are not implied to be an exact version of any other system, nor do we claim any endorsement of the Doctors

Verve™

Precision, strength and reliability

Verve buccal tubes are designed for guaranteed ease of use, treatment efficiency and predictable results.

Verve buccal tubes are precision manufactured for strength and reliability, with a low profile to deliver maximum comfort for your patients.



1st Molar	ROTH*	MBT*	2nd Molar	ROTH*	MBT*
UR6 .022"	DV-162-00	DV-162-40	UR7 .022"	DV-172-00	DV-172-40
UL6 .022"	DV-262-00	DV-262-40	UL7 .022"	DV-272-00	DV-272-40
LR6 .022"	DV-362-00	DV-362-40	LR7 .022"	DV-372-00	DV-372-40
LL6 .022"	DV-462-00	DV-462-40	LL7 .022"	DV-472-00	DV-472-40



Rounded ball hook

For improved patient comfort

Low profile MIM design

Great comfort for patients

Funnelled entry

For easy wire insertion

Indented mesh pad

For precise placement

Torque in the base

For efficient treatment

Permanent code markings

For easy identification

Flat buccal surface

With special cut out aids handling and positioning

80 gauge mesh contoured base

For reliable bonding

Optimum size pad

Ensures maximum retention

essentials™

Value Bondable Buccal Tubes

Our popular Essentials tubes are precision manufactured for a strong and compact design.

The 80 gauge contoured mesh base makes them easy to position and ensures reliable bonding whilst the chamfered entrance makes archwire placement easy.

- All-in-one structure for maximum strength
- Precision casting for intricate design
- Low profile for patient comfort
- Indented mesh pad for easy placement
- Enlarged archwire entry hole, makes archwire placement easy
- Coloured positioning notch to aid placement

2nd Molar Tubes



1st Molar Tubes



1st Molar .022"	ROTH*	MBT*
UR6	DE-106-00	DE-106-40
UL6	DE-206-00	DE-206-40
LR6	DE-306-00	DE-306-40
LL6	DE-406-00	DE-406-40
2nd Molar .022"	ROTH*	MBT*
UR7	DE-107-00	DE-107-40
UL7	DE-207-00	DE-207-40
LR7	DE-307-00	DE-307-40
LL7	DE-407-00	DE-407-40

*The TOC versions of these prescriptions are not implied to be an exact version of any other system nor do we claim any endorsement of the doctors.



Premium



Quality



Value

WIRE PRODUCTS

Sentalloy® Archwires

A Leader in Superelastic Wires

What makes Sentalloy such an exceptional wire?

An excellent, low-friction, superelastic, NiTi archwire for straightening and alignment. Sentalloy wires feature thermally activated shape memory and provide near constant forces.

Sentalloy wires are designed to deliver a gentle, light continuous force; moving teeth without dissipation of force and periodontal stress. The “secret” to Sentalloy’s superiority is its use of body temperature to activate the characteristics inherent in the wire, to give you superelasticity and shape memory qualities not found in competitor’s wires. All Sentalloy wires are individually wrapped to help prevent cross contamination.

Body Heat Activation

At room temperature, Sentalloy wire is soft, pliable and easy to engage. Once warmed to body temperature the wire gently and predictably guides the teeth to the present arch form.

Superelasticity

Even when severely malposed, Sentalloy continues to exert its gentle, near constant forces as the tooth moves for greater efficiency.

Shape Memory Effect

Sentalloy will take displacements up to 90 degrees without deforming. Its overwhelming desire to return to its original shape actually promotes tooth movement with fewer wire changes and fewer patient visits.

SENTALLOY - STRAIGHT LENGTHS (Pk 10)	
Size	Code
.012" 7" Lengths	02-511-80
.016" 7" Lengths	02-511-82
.018" 7" Lengths	02-511-83

SENTALLOY - ROUND (Pk 10)				
Light	Accuform (FULL)		Ideal Arch (EURO)	
	Upper	Lower	Upper	Lower
.014"	02-511-012	02-511-512	02-517-012	02-517-512
.016"	02-511-022	02-511-522	02-517-022	02-517-522
.018"	02-511-032	02-511-532	02-517-032	02-517-532
.020"	02-511-042	02-511-542	02-517-042	02-517-542
Medium				
.014"	02-511-112	02-511-612	02-517-112	02-517-612
.016"	02-511-122	02-511-622	02-517-122	02-517-622
.018"	02-511-132	02-511-632	02-517-132	02-517-632
.020"	02-511-142	02-511-642	02-517-142	02-517-642
Heavy				
.014"	02-511-212	02-511-712	02-517-212	02-517-712
.016"	02-511-222	02-511-722	02-517-222	02-517-722
.018"	02-511-232	02-511-732	02-517-232	02-517-732
.020"	02-511-242	02-511-742	-	-



SENTALLOY ARCHWIRE OPTIONS:

Sentalloy: Initial archwire - round, superelastic NiTi, near constant force.

NeoSentalloy: Second archwire - square or rectangular with heat activation and true elasticity with low forces

BioForce: Advanced archwire - square or rectangular for early to mid treatment with forces on the same wire increasing from 100-300 grams. Superelastic and heat activation

NeoSentalloy and BioForce with IonGuard: For low friction

NEO SENTALLOY - RECTANGULAR (Pk 10)				
Force	Accuform (FULL)		Ideal Arch (EURO)	
	Upper	Lower	Upper	Lower
80 gram				
.016" x .016"	02-523-012	02-523-512	02-526-012	02-526-512
.016" x .022"	02-523-022	02-523-522	02-526-022	02-526-522
100 gram				
.017" x .025"	02-523-032	02-523-532	02-526-032	02-526-532
.018" x .018"	02-523-042	02-523-542	02-526-042	02-526-542
.018" x .025"	02-523-052	02-523-552	02-526-052	02-526-552
.020" x .020"	02-523-072	02-523-572	02-526-072	02-526-572
.021" x .028"	02-523-082	02-523-582	02-526-082	02-526-582
160 gram				
.016" x .016"	02-523-112	02-523-612	02-526-112	02-526-612
.016" x .022"	02-523-122	02-523-622	02-526-122	02-526-622
200 gram				
.017" x .025"	02-523-132	02-523-632	02-526-132	02-526-632
.018" x .018"	02-523-142	02-523-642	02-526-142	02-526-642
.018" x .025"	02-523-152	02-523-652	02-526-152	02-526-652
.019" x .025"	02-523-162	02-523-662	-	-
.020" x .020"	02-523-172	02-523-672	02-526-172	02-526-672
.021" x .028"	02-523-182	02-523-682	02-526-182	02-526-682
240 gram				
.016" x .016"	02-523-212	02-523-712	02-526-212	02-526-712
.016" x .022"	02-523-222	02-523-722	02-526-222	02-526-722
300 gram				
.017" x .025"	02-523-232	02-523-732	02-526-232	02-526-732
.018" x .018"	02-523-242	02-523-742	02-526-242	02-526-742
.018" x .025"	02-523-252	02-523-752	-	-
.020" x .020"	02-523-272	02-523-762	02-526-272	02-526-772
.021" x .028"	02-523-282	02-523-772	-	-

BioForce[®] + Archwires



Force When You Need It, Expression When You Want It

Extreme wire bends and challenging cases can put your archwire to the test. Not only must the wire be easy to bend and engage, but it must also resist deformation and fully express the desired forces while limiting excess patient discomfort. Nickel Titanium BioForce PLUS archwires from DENTSPLY GAC are engineered with an unmatched combination of metallurgical expertise, technological resources and clinical knowledge. As a result, they deliver an ideal combination of performance, reliability and workability.



The Biologically Correct Archwire

BioForce PLUS uses only the ideal force needed to move the respective teeth, while preventing excessive or undesired force that can be experienced in single zone wires. The proprietary formulation is body-heat activated, starting with low, gentle forces for the anteriors, increasing toward the posterior and plateauing in the molar region. This provides the option of simultaneously leveling, aligning and initiating torque expression potentially reducing the number of archwire changes in your treatment plan.

As Jarabak tabulated, 'it takes less force to move a small, single rooted lower anterior tooth than a large, tri-rooted molar.' BioForce PLUS is engineered to Jarabak standards.

Enhancing Performance

When it comes to optimal case progression, symbiotic relationship between your chosen archwire and the bracket of your choice is essential. BioForce PLUS delivers a complete and consistent performance across a wide variety of different bracket prescriptions across all brands including all of your favourite DENTSPLY GAC systems.

- The Anterior Region of BioForce PLUS archwires have the lowest heat-activated force as anterior teeth have the lightest roots.
- The Bicuspid Region of BioForce PLUS archwires delivers a slightly greater heat-activated force to move larger rooted bicuspids.
- The Posterior Region of BioForce PLUS archwires has the greatest heat-activated force for moving the strong-rooted molars.



BIOFORCE PLUS ADVANTAGES:

- Three force zones, delivering gradually increasing forces from the anterior to the posterior with no dead zones in between
- Ability to enter the working stage earlier, in many cases eliminating a wire from your sequence
- Near constant force designed for a comfortable treatment experience
- Superelastic to express even the most extreme bends
- Heat activated for ideal workability at room temperature
- Designed to take displacements up to 90° without permanent deformation
- Greater ability to release stored energy consistently when compared to beta-titanium or stainless steel wires
- Available with IonGuard to reduce friction



Size	ACCUFORM (FULL)			IDEAL ARCH (EURO)	
	Pk 10	Upper	Lower	Upper	Lower
.016" x .016"	medium	J02-528-012	J02-528-512	J02-529-012	J02-529-512
	large	J02-528-013	J02-528-513	-	-
.016" x .022"	medium	J02-528-022	J02-528-522	J02-529-022	J02-528-522
	large	J02-528-023	J02-528-523	-	-
.018" x .018"	medium	J02-528-042	J02-528-542	J02-529-042	J02-529-542
	large	J02-528-043	J02-528-543	-	-
.018" x .025"	medium	J02-528-052	J02-528-552	J02-529-052	J02-529-552
.019" x .025"	medium	J02-528-062	J02-528-562	J02-529-062	J02-529-562
	large	J02-528-063	J02-528-563	-	-
.020" x .020"	medium	J02-528-072	J02-528-572	J02-529-072	J02-529-572
	large	J02-528-073	J02-528-573	-	-
.021" x .028"	medium	J02-528-082	J02-528-582	-	-
.022" x .018"	medium	J02-528-092	J02-528-592	-	-

Hi-Q™ Archwires

A range of high quality archwires

High quality nickel titanium and thermal nickel titanium wires which are designed to provide a low continuous force, with shape superior memory and elasticity characteristics. Manufactured to precise tolerances, Hi-Q wires offer all the features and benefits you would expect from a high performance wire.



- Super elasticity - very flexible and easy to engage
- Superior shape memory - stays active right throughout treatment
- Low, constant force - for most efficient tooth movement and increased patient comfort
- Polished finish - low friction
- Rigorous quality control - every wire performs the same

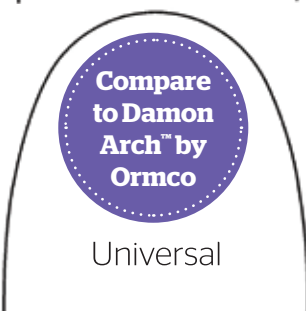
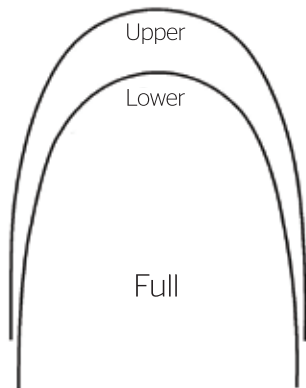
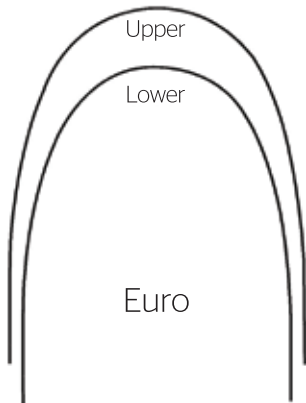

Nickel Titanium

EURO (Pk10)		
Size	Upper	Lower
.012"	HQN-012-00	HQN-012-10
.014"	HQN-014-00	HQN-014-10
.016"	HQN-016-00	HQN-016-10
.018"	HQN-018-00	HQN-018-10
.020"	HQN-020-00	HQN-020-10
.016" x .016"	HQN-616-00	HQN-616-10
.016" x .022"	HQN-622-00	HQN-622-10
.017" x .025"	HQN-725-00	HQN-725-10
.018" x .018"	HQN-818-00	HQN-818-10
.018" x .025"	HQN-825-00	HQN-825-10
.019" x .025"	HQN-925-00	HQN-925-10
.020" x .020"	HQN-220-00	HQN-220-10

FULL (Pk10)		
Size	Upper	Lower
.012"	HQN-012-01	HQN-012-11
.014"	HQN-014-01	HQN-014-11
.016"	HQN-016-01	HQN-016-11
.018"	HQN-018-01	HQN-018-11
.020"	HQN-020-01	HQN-020-11
.016" x .016"	HQN-616-01	HQN-616-11
.016" x .022"	HQN-622-01	HQN-622-11
.017" x .025"	HQN-725-01	HQN-725-11
.018" x .018"	HQN-818-01	HQN-818-11
.018" x .025"	HQN-825-01	HQN-825-11
.019" x .025"	HQN-925-01	HQN-925-11
.020" x .020"	HQN-220-01	HQN-220-11

UNIVERSAL (Pk10)	
Size	U/L
.012"	HQN-012-55
.014"	HQN-014-55
.016"	HQN-016-55
.018"	HQN-018-55
.014" x .025"	HQN-425-55
.016" x .025"	HQN-625-55
.018" x .025"	HQN-825-55

Thermal Nickel Titanium

EURO (Pk10)		
Size	Upper	Lower
.014"	HQ-014-00	HQ-014-10
.016"	HQ-016-00	HQ-016-10
.018"	HQ-018-00	HQ-018-10
.020"	HQ-020-00	HQ-020-10
.016" x .016"	HQ-616-00	HQ-616-10
.016" x .022"	HQ-622-00	HQ-622-10
.017" x .025"	HQ-725-00	HQ-725-10
.018" x .018"	HQ-818-00	HQ-818-10
.018" x .025"	HQ-825-00	HQ-825-10
.019" x .025"	HQ-925-00	HQ-925-10
.020" x .020"	HQ-220-00	HQ-220-10

FULL (Pk10)		
Size	Upper	Lower
.014"	HQ-014-01	HQ-014-11
.016"	HQ-016-01	HQ-016-11
.018"	HQ-018-01	HQ-018-11
.020"	HQ-020-01	HQ-020-11
.016" x .016"	HQ-616-01	HQ-616-11
.016" x .022"	HQ-622-01	HQ-622-11
.017" x .025"	HQ-725-01	HQ-725-11
.018" x .018"	HQ-818-01	HQ-818-11
.018" x .025"	HQ-825-01	HQ-825-11
.019" x .025"	HQ-925-01	HQ-925-11
.020" x .020"	HQ-220-01	HQ-220-11

UNIVERSAL (Pk10)	
Size	U/L
.014"	HQ-014-55
.016"	HQ-016-55
.018"	HQ-018-55
.014" x .025"	HQ-425-55
.016" x .022"	HQ-622-55
.016" x .025"	HQ-625-55
.018" x .025"	HQ-825-55

All trademarks are the property of their respective owners

essentials™

Value archwires

- Consistent quality guaranteed
- Euro arch shape
- Bulk pricing available

Nickel Titanium

Super Elastic Nickel Titanium archwires with an extra smooth finish which reduces friction. Provides efficient treatment with gentle and consistent forces.

Size	EURO (Pk10)	
	Upper	Lower
.012"	HEN-012-00	HEN-012-10
.014"	HEN-014-00	HEN-014-10
.016"	HEN-016-00	HEN-016-10
.018"	HEN-018-00	HEN-018-10
.020"	HEN-020-00	HEN-020-10
.016" x .022"	HEN-622-00	HEN-622-10
.017" x .025"	HEN-725-00	HEN-725-10
.018" x .025"	HEN-825-00	HEN-825-10
.019" x .025"	HEN-925-00	HEN-925-10
.020" x .020"	HEN-220-00	HEN-220-10

Thermal Nickel Titanium

Heat activated archwires with great shape memory characteristics. Soft and pliable at room temperature, they deliver gentle forces for maximum patient comfort and efficient tooth movement. Our Essentials wires really do offer superb value for money!

Size	EURO (Pk10)	
	Upper	Lower
.012"	HE-012-00	HE-012-10
.014"	HE-014-00	HE-014-10
.016"	HE-016-00	HE-016-10
.018"	HE-018-00	HE-018-10
.016" x .022"	HE-622-00	HE-622-10
.017" x .025"	HE-725-00	HE-725-10
.018" x .025"	HE-825-00	HE-825-10
.019" x .025"	HE-925-00	HE-925-10
.020" x .020"	HE-220-00	HE-220-10

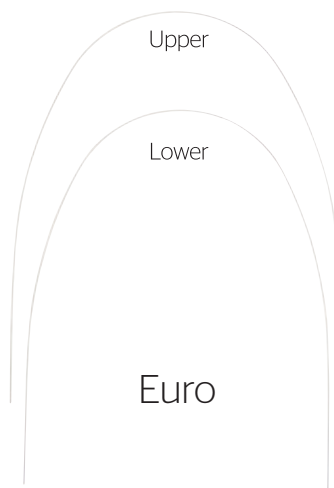

Full Essentials range available



Wires can be supplied individually wrapped for just a small additional charge. Simply add '+' to the end of the code when ordering.

Copperloy® Nickel Titanium

An addition to the range of best selling and world renowned Sentalloy® wires

The Copperloy family is designed to deliver a comfortable and efficient experience. The addition of copper enhances the thermal properties of the wire.

Unique Properties Of Copperloy Superelastic Wires

- Scientifically Proven**
 Precision engineered Copper NiTi allows the wires to express fast, consistent movement.
- Consistent Performance**
 Achieve a steady, complete expression of force across all wire sizes for a more precise finishing point. Copper NiTi wires are also more resistant to permanent deformation.
- Resists Breakage**
 Controlled load ranges to reduce breakage.
- Easy Engagement**
 Due to low hysteresis, the smaller loading forces make wire engagement in the slot easier, even in severe cases.

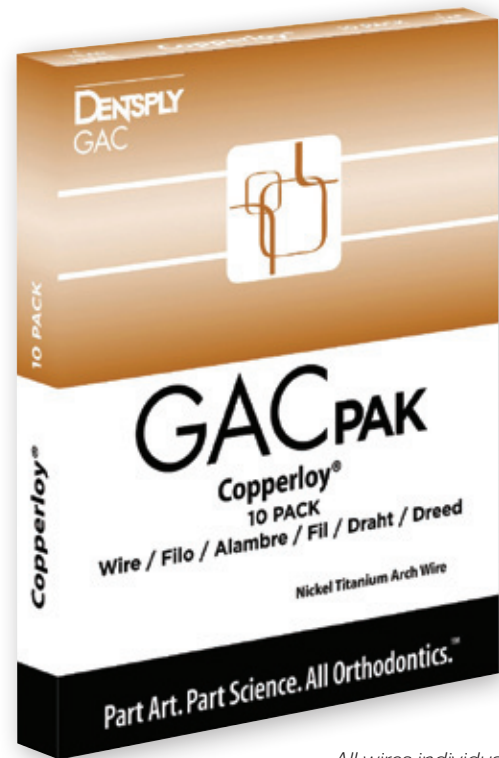

All wires individually wrapped and midline etched

UNIVERSAL T1 27 Degrees (Pk10)	
Size	Without Stops
.013"	302-100-00
.014"	302-100-01
.016"	302-100-02
.018"	302-100-03
.014" x .025"	302-100-04
.016" x .022"	302-100-05
.016" x .025"	302-100-06
.017" x .025"	302-100-07
.018" x .025"	302-100-08
.019" x .025"	302-100-09

UNIVERSAL T2 35 Degrees (Pk10)	
Size	Without Stops
.016"	302-100-10
.018"	302-100-11
.016" x .022"	302-100-12
.017" x .025"	302-100-13
.018" x .025"	302-100-14
.019" x .025"	302-100-15

IDEAL (EURO) - T1 27 Degrees (Pk10)		
Size	Upper	Lower
.013"	302-200-01	302-210-01
.014"	302-200-02	302-210-02
.016"	302-200-04	302-210-04
.018"	302-200-06	302-210-06
.014" x .025"	302-200-08	302-210-08
.016" x .022"	302-200-10	302-210-10
.016" x .025"	302-200-12	302-210-12
.017" x .025"	302-200-14	302-210-14
.018" x .025"	302-200-15	302-210-15
.019" x .025"	302-200-16	302-210-16

IDEAL (EURO) - T2 35 Degrees (Pk10)		
Size	Upper	Lower
.016"	302-200-17	302-210-17
.018"	302-200-18	302-210-18
.016" x .022"	302-200-19	302-210-19
.017" x .017"	302-200-20	302-210-20
.017" x .025"	302-200-21	302-210-21
.018" x .025"	302-200-22	302-210-22
.019" x .025"	302-200-23	302-210-23
.020" x .020"	302-200-24	302-210-24
.021" x .025"	302-200-25	302-210-25

IDEAL (EURO) - T3 40 Degrees (Pk10)		
Size	Upper	Lower
.016" x .022"	302-200-26	302-210-26
.017" x .025"	302-200-27	302-210-27
.019" x .025"	302-200-28	302-210-28
.021" x .025"	302-200-29	302-210-29

ACCUFORM (FULL) - T1 27 Degrees (Pk10)		
Size	Upper	Lower
.013"	302-300-01	302-310-01
.014"	302-300-02	302-310-02
.016"	302-300-04	302-310-04
.018"	302-300-06	302-310-06
.014" x .025"	302-300-08	302-310-08
.016" x .022"	302-300-10	302-310-10
.016" x .025"	302-300-12	302-310-12
.017" x .025"	302-300-14	302-310-14
.018" x .025"	302-300-15	302-310-15
.019" x .025"	302-300-16	302-310-16

ACCUFORM (FULL) - T2 35 Degrees (Pk10)		
Size	Upper	Lower
.016"	302-300-18	302-310-18
.018"	302-300-20	302-310-20
.016" x .022"	302-300-22	302-310-22
.017" x .017"	302-300-24	302-310-24
.017" x .025"	302-300-26	302-310-26
.018" x .025"	302-300-28	302-310-28
.019" x .025"	302-300-30	302-310-30
.020" x .020"	302-300-32	302-310-32
.021" x .025"	302-300-34	302-310-34

ACCUFORM (FULL) - T3 40 Degrees (Pk10)		
Size	Upper	Lower
.016" x .022"	302-300-36	302-310-36
.017" x .025"	302-300-38	302-310-38
.019" x .025"	302-300-40	302-310-40
.021" x .025"	302-300-42	302-310-42



All trademarks are the property of their respective owners

Hi-Q™ Copper Nickel Titanium

Consistent high quality

The blend of copper in the raw material combined with an advanced manufacturing process provides unique benefits for you and your patients.

The lighter forces and high flexibility of Hi-Q Copper NiTi allows for easier wire engagement in moderate to severely misaligned cases and reduces patient discomfort. Hi-Q Copper NiTi maintains a constant force and generates more consistent tooth movement as the wire is active for longer in the optimal force range thus allowing fewer archwire changes. The higher the temperature transition, the lower the relative forces delivered by the wire.



EURO (Pk10)			
Size	Degrees	Upper	Lower
.014"	27°	HQ-014-27EU	HQ-014-27EL
.016"	35°	HQ-016-35EU	HQ-016-35EL
.018"	35°	HQ-018-35EU	HQ-018-35EL
.016" x .022"	35°	HQ-622-35EU	HQ-622-35EL
.017" x .025"	35°	HQ-725-35EU	HQ-725-35EL
.019" x .025"	35°	HQ-925-35EU	HQ-925-35EL
.020" x .020"	35°	HQ-220-35EU	HQ-220-35EL

FULL (Pk10)			
Size	Degrees	Upper	Lower
.018"	35°	HQ-018-35FU	HQ-018-35FL
.019" x .025"	35°	HQ-925-35FU	HQ-925-35FL

UNIVERSAL (Pk10)			
Size	Degrees	Without Stops	With Stops
.013"	27°	-	HQ-013-27US
.014"	27°	HQ-014-27U	HQ-014-27US
.018"	27°	HQ-018-27U	HQ-018-27US
.014" x .025"	27°	-	HQ-425-27US
.018" x .025"	27°	HQ-825-27U	HQ-825-27US

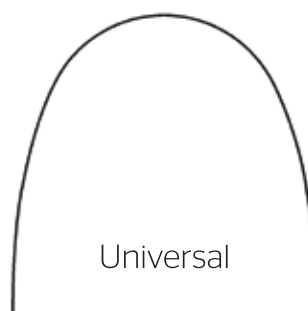
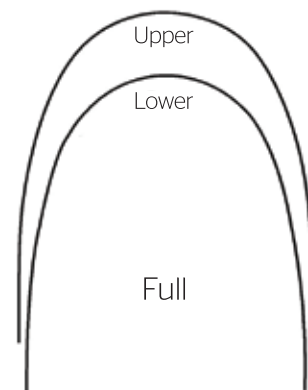
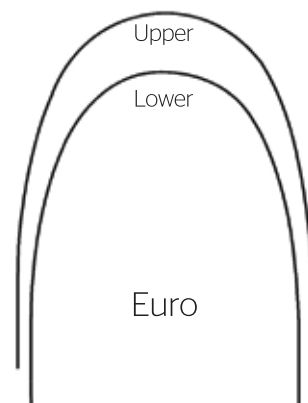

For medium force use 35°

For higher force use 27°



Beta Titanium Wire

Premium Nickel Free Wire



DENTSPLY GAC's Resolve Beta Titanium archwires are processed in smaller batches for greater consistency. They are then micro finished for smoother edges and reduced friction, while the long shape offers the ability to make more bends and loops. Resolve contains no nickel that can cause allergic reactions in some patients. It can be used at any stage of treatment, but it is especially effective where moderate forces are necessary for early torque control and final detailing. High springback and flexibility with lower forces and less breakage make Resolve the new standard in Beta Titanium.

- TiMo Alloy wire
- Nickel free
- Low breakage rate
- Micro finished for smoother finish and lower friction

For more Nickel free products see p64



Beta Titanium



Hi-Q Beta Titanium archwires deliver greater forces than nickel titanium without the same stiffness of stainless steel. They allow you to place larger wire sizes earlier in treatment and increase treatment efficiency.

Hi-Q Beta Titanium offers excellent bendability allowing you to form loops and bends easily. They have a smooth, polished finish for superb sliding mechanics and reduced friction. The wires are also nickel free to prevent any allergic reactions.

Size	ACCUFORM (FULL)			IDEAL ARCH (EURO)	
	Pk 10	Upper	Lower	Upper	Lower
.016"	small	03-016-931	03-016-941	-	-
	medium	03-016-932	03-016-942	-	-
	large	03-016-933	03-016-943	-	-
.018"	small	03-018-931	03-018-941	-	-
	medium	03-018-932	03-018-942	-	-
	large	03-018-933	03-018-943	-	-
.016" x .022"	small	03-622-931	03-622-941	-	-
	medium	03-622-932	03-622-942	03-622-952	03-622-962
	large	03-622-933	03-622-943	-	-
.017" x .025"	small	03-725-931	03-725-941	-	-
	medium	03-725-932	03-725-942	03-725-952	03-725-962
	large	03-725-933	03-725-943	-	-
.018" x .018"	small	03-818-931	03-818-941	-	-
	medium	03-818-932	03-818-942	03-818-952	03-818-962
	large	03-818-933	03-818-943	-	-
.018" x .025"	small	03-825-931	03-825-941	-	-
	medium	03-825-932	03-825-942	03-825-952	03-825-962
	large	03-825-933	03-825-943	-	-
.019" x .025"	small	03-925-931	03-925-941	-	-
	medium	03-925-932	03-925-942	03-925-952	03-925-962
	large	03-925-933	03-925-943	-	-
.021" x .025"	small	03-125-931	03-125-941	-	-
	medium	03-125-932	03-125-942	03-125-952	03-125-962
	large	03-125-933	03-125-943	-	-
.022" x .018"	medium	03-218-932	03-218-942	-	-

Size	EURO (Pk 10)	
	Upper	Lower
.016"	HQB-016-00	HQB-016-10
.018"	HQB-018-00	HQB-018-10
.016" x .016"	HQB-616-00	HQB-616-10
.016" x .022"	HQB-622-00	HQB-622-10
.017" x .025"	HQB-725-00	HQB-725-10
.018" x .018"	HQB-818-00	HQB-818-10
.018" x .025"	HQB-825-00	HQB-825-10
.019" x .025"	HQB-925-00	HQB-925-10
.021" x .025"	HQB-225-00	HQB-225-10

Size	FULL (Pk 10)	
	Upper	Lower
.016"	HQB-016-01	HQB-016-11
.018"	HQB-018-01	HQB-018-11
.016" x .022"	HQB-622-01	HQB-622-11
.017" x .025"	HQB-725-01	HQB-725-11
.018" x .018"	HQB-818-01	HQB-818-11
.018" x .025"	HQB-825-01	HQB-825-11
.019" x .025"	HQB-925-01	HQB-925-11
.021" x .025"	HQB-225-01	HQB-225-11

Size	UNIVERSAL (Pk 10)
	Upper/Lower
.016" x .025"	HQB-625-55
.017" x .025"	HQB-725-55
.019" x .025"	HQB-925-55

Reverse Curve

Retranol™ Reverse Curve Archwire



Retranol, "The Bite Opener", reverse curve archwires are produced from work hardened nickel titanium. This wire provides a greater working range than stainless steel wires and affords ideal dimensional stability to avoid "dumping" the anteriors during retractions. Opening the bite now requires less than half the time that was needed with stainless steel. Retranol also needs fewer archwire changes and adjustments. Throughout treatment, Retranol remains active without deforming.

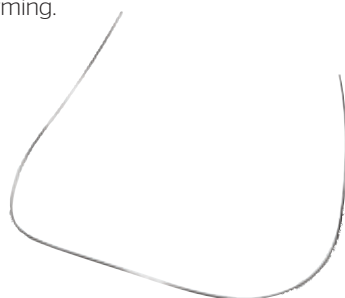

Size (Pk10)	Upper	Lower
.016"	03-016-38	03-016-39
.018"	03-018-38	03-018-39
.016" x .022"	03-622-38	03-622-39
.017" x .025"	03-725-38	03-725-39
.018" x .025"	03-825-38	03-825-39
.019" x .025"	03-925-38	03-925-39

Reverse Curve Nickel Titanium Archwire



Hi-Q Reverse Curve NiTi wires offer all the advantages of super elastic continuous force levels combined with the benefits of a reverse curve wire. Designed for opening and closing the bite, they also provide excellent levelling and aligning.



Size	EURO (Pk 10)	
	Upper	Lower
.012"	HQR-012-00	HQR-012-10
.014"	HQR-014-00	HQR-014-10
.016"	HQR-016-00	HQR-016-10
.018"	HQR-018-00	HQR-018-10
.020"	HQR-020-00	HQR-020-10
.016" x .016"	HQR-616-00	HQR-616-10
.016" x .022"	HQR-622-00	HQR-622-10
.017" X .025"	HQR-725-00	HQR-725-10
.018" X .018"	HQR-818-00	HQR-818-10
.018" x .025"	HQR-825-00	HQR-825-10
.019" x .025"	HQR-925-00	HQR-925-10
.020" x .020"	HQR-220-00	HQR-220-10
.021" X .025"	HQR-225-00	HQR-225-10

AJ Wilcock® Australian Wire

Spools

The Regular and Regular Plus are easily formed and are excellent wires for general use and utility wires.

The Special, Special Plus and Premium wires are ideal for bite opening and where high resilience is required.



Lengths

Convenient to use and easy to store, these pulse straightened wires come 30 pieces per tube and are available in every grade and dimension.

This is one of the most popular products and are especially valuable when time is a factor.



Size	Regular	Regular Plus	Special	Special Plus	Premium
.012"	TOC229-000	TOC229-010	TOC229-020	TOC229-030	TOC229-040
.014"	TOC230-100	TOC230-110	TOC230-120	TOC230-130	TOC230-140
.016"	TOC231-300	TOC231-310	TOC231-320	TOC231-330	TOC231-340
.018"	TOC232-400	TOC232-410	TOC232-420	TOC232-430	TOC232-440
.020"	TOC233-500	TOC233-510	TOC233-520	TOC233-530	TOC233-540

Size	Regular	Regular Plus	Special	Special Plus
.014"	TOC230-101	TOC230-111	TOC230-121	TOC230-131
.016"	TOC231-301	TOC231-311	TOC231-321	TOC231-331
.018"	TOC232-401	TOC232-411	TOC232-421	TOC232-431
.020"	TOC233-501	TOC233-511	TOC233-521	TOC233-531

Stainless Steel Archwires

Premium Stainless Steel



DENTSPLY GAC's Stainless Steel wire is made from premium type 304 VAR steel. It's virtually free from imperfections that can cause brittleness and breakage. Each lot is tested for brittleness using bend on wire blocks. All DENTSPLY GAC wire is Instron tensile tested both before and after heat treating to ensure consistency and all the wires are tested for consistent rebound and deflection using a Tinius Olsen stiffness tester. The square and rectangular wires are shaped to the tightest standards in the industry and laser monitored for total batch consistency.



IDEAL ARCH (EURO Pk 10)		
Size	Upper	Lower
.014"	03-014-652	03-014-662
.016"	03-016-652	03-016-662
.018"	03-018-652	03-018-662
.020"	03-020-652	03-020-662
.016" x .022"	03-622-652	03-622-662
.017" x .025"	03-725-652	03-725-662
.018" x .025"	03-825-652	03-825-662
.019" x .025"	03-925-652	03-925-662
.020" x .020"	03-220-652	03-220-662
.021" x .025"	03-125-652	03-125-662

- 100% inspection for shape, flatness, finish and torque
- A perfect balance of spring-back and formability
- All archwires are individually wrapped



Product	Code
GAC Pak Rack	02-500-02

Stainless Steel Archwires

Manufactured from the highest quality medical grade steel, our popular Hi-Q Stainless Steel Archwires accepts bends without breakage and provides consistent performance.



- High tensile strength
- Polished for reduced friction
- Consistent quality

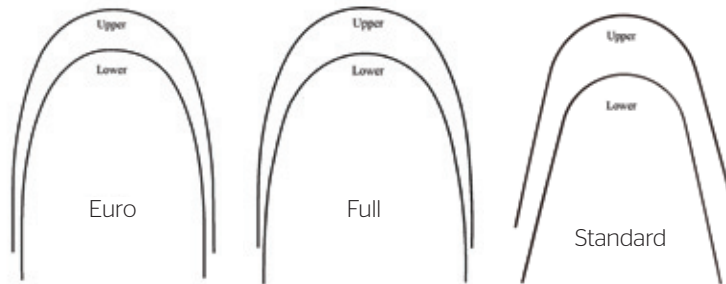

EURO (Pk 100 Round / Pk 10 Rect.)		
Size	Upper	Lower
.012"	HQS-012-00	HQS-012-10
.014"	HQS-014-00	HQS-014-10
.016"	HQS-016-00	HQS-016-10
.018"	HQS-018-00	HQS-018-10
.020"	HQS-020-00	HQS-020-10
.016" x .016"	HQS-616-00	HQS-616-10
.016" x .022"	HQS-622-00	HQS-622-10
.017" X .022"	HQS-722-00	HQS-722-10
.017" x .025"	HQS-725-00	HQS-725-10
.018" X .018"	HQS-818-00	HQS-818-10
.018" x .022"	HQS-822-00	HQS-822-10
.018" x .025"	HQS-825-00	HQS-825-10
.019" x .025"	HQS-925-00	HQS-925-10
.021" x .025"	HQS-225-00	HQS-225-10

FULL (Pk 100 Round / Pk 10 Rect.)		
Size (Pk 10)	Upper	Lower
.012"	HQS-012-01	HQS-012-11
.014"	HQS-014-01	HQS-014-11
.016"	HQS-016-01	HQS-016-11
.018"	HQS-018-01	HQS-018-11
.020"	HQS-020-01	HQS-020-11
.016" x .016"	HQS-616-01	HQS-616-11
.016" x .022"	HQS-622-01	HQS-622-11
.017" X .022"	HQS-722-01	HQS-722-11
.017" x .025"	HQS-725-01	HQS-725-11
.018" x .018"	HQS-818-01	HQS-818-11
.018" X .022"	HQS-822-01	HQS-822-11
.018" x .025"	HQS-825-01	HQS-825-11
.019" x .025"	HQS-925-01	HQS-925-11
.021" x .025"	HQS-225-01	HQS-225-11

STANDARD (Pk 100 Round / Pk 10 Rect.)		
Size (Pk 100)	Upper	Lower
.016"	HQS-016-05	HQS-016-15
.018"	HQS-018-05	HQS-018-15
.020"	HQS-020-05	HQS-020-15
.016" x .022"	HQS-622-05	HQS-622-15
.017" X .025"	HQS-725-05	HQS-725-15
.018" X .022"	HQS-822-05	HQS-822-15
.018" x .025"	HQS-825-05	HQS-825-15
.019" x .025"	HQS-925-05	HQS-925-15
.021" X .025"	HQS-225-05	HQS-225-15

Value Stainless Steel Archwires

- Bright finish for reduced friction
- Euro arch shape
- Outstanding value

Size	EURO (Pk10)	
	Upper	Lower
.012"	HES-012-00	HES-012-10
.014"	HES-014-00	HES-014-10
.016"	HES-016-00	HES-016-10
.018"	HES-018-00	HES-018-10
.020"	HES-020-00	HES-020-10
.016" x .016"	HES-616-00	HES-616-10
.016" x .022"	HES-622-00	HES-622-10
.016" x .025"	HES-625-00	HES-625-10
.017" x .025"	HES-725-00	HES-725-10
.018" x .022"	HES-822-00	HES-822-10
.018" x .025"	HES-825-00	HES-825-10
.019" x .025"	HES-925-00	HES-925-10
.021"x.025"	HES-225-00	HES-225-10

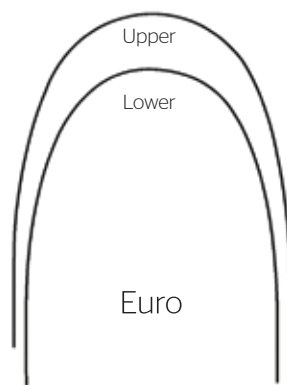

essentials™

Full Essentials range brochure available



Stainless Steel Posted Archwires

High quality brass posted wires with the strongest solder joints in the industry. Provides excellent results during the retraction and closing of spaces as well as giving added benefits such as attaching headgear, elastics and springs. The small solder spot on the wire allows for easier archwire engagement without bracket impingement.

- Highest quality stainless steel
- Strong solder joints
- Consistent quality
- Ideal post length - 5mm
- Supplied in a unique protective box



Hi-Q™
ARCHWIRES



Size	EURO (Pk10)		
	.016" x .022"	.018" x .025"	.019" x .025"
22mm	HQP-1622-22E	HQP-1825-22E	HQP-1925-22E
24mm	HQP-1622-24E	HQP-1825-24E	HQP-1925-24E
26mm	HQP-1622-26E	HQP-1825-26E	HQP-1925-26E
28mm	HQP-1622-28E	HQP-1825-28E	HQP-1925-28E
30mm	HQP-1622-30E	HQP-1825-30E	HQP-1925-30E
32mm	HQP-1622-32E	HQP-1825-32E	HQP-1925-32E
34mm	HQP-1622-34E	HQP-1825-34E	HQP-1925-34E
36mm	HQP-1622-36E	HQP-1825-36E	HQP-1925-36E
38mm	HQP-1622-38E	HQP-1825-38E	HQP-1925-38E
40mm	HQP-1622-40E	HQP-1825-40E	HQP-1925-40E

Size	FULL (Pk 10)		
	.016" x .022"	.018" x .025"	.019" x .025"
22mm	HQP-1622-22F	HQP-1825-22F	HQP-1925-22F
24mm	HQP-1622-24F	HQP-1825-24F	HQP-1925-24F
26mm	HQP-1622-26F	HQP-1825-26F	HQP-1925-26F
28mm	HQP-1622-28F	HQP-1825-28F	HQP-1925-28F
30mm	HQP-1622-30F	HQP-1825-30F	HQP-1925-30F
32mm	HQP-1622-32F	HQP-1825-32F	HQP-1925-32F
34mm	HQP-1622-34F	HQP-1825-34F	HQP-1925-34F
36mm	HQP-1622-36F	HQP-1825-36F	HQP-1925-36F
38mm	HQP-1622-38F	HQP-1825-38F	HQP-1925-38F
40mm	HQP-1622-40F	HQP-1825-40F	HQP-1925-40F

High Aesthetic Archwire

Sentalloy® High Aesthetic

An excellent, low-friction, superelastic, NiTi archwire for straightening and alignment. Sentalloy wires feature thermally activated shape memory and provide near constant forces.

BioForce® High Aesthetic

BioForce High Aesthetic archwire is part of the first and only family of biologically correct archwires. The NiTi BioForce wires apply low, gentle forces to the anteriors and increasingly stronger forces across the posteriors until plateauing at the molars. Beginning at approximately 100 grams in the anterior region and increasing to approximately 300 grams in the molar region, BioForce provides the right force to each tooth, reducing the number of wire changes and providing greater patient comfort.

Reduced visibility and outstanding performance

Featuring similar, low-visibility properties, Dentsply GAC's Sentalloy and BioForce High Aesthetic Archwires are the perfect complement to any ceramic bracket.

A unique, rhodium process provides a low-reflectivity surface, giving each wire a soft, frosted appearance. Both Sentalloy High Aesthetic and BioForce High Aesthetic have the original properties and provide the same excellent performance as original Sentalloy and BioForce wires.



Aesthetic Advantages

- Rhodium process provides low reflectivity for reduced visibility
- Matches the appearance of the In-Ovation C clip
- Complements any ceramic bracket
- Provides the same outstanding performance as standard Sentalloy and BioForce wires



BioForce High Aesthetic Archwire

Flow of Force Over Arch Wire

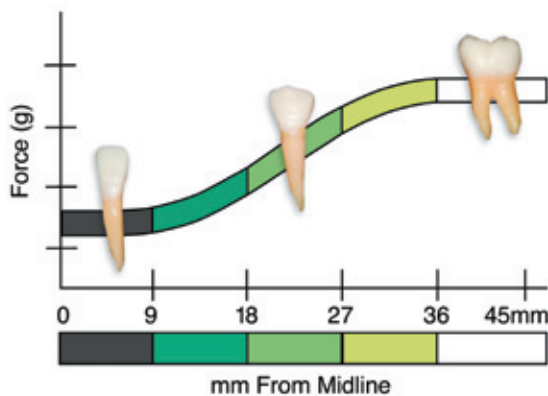

ACCUFORM - FULL (Pk10)		
Sentalloy	Upper	Lower
.014"	02-711-112	02-711-612
.016"	02-711-122	02-711-622
.018"	02-711-132	02-711-632
BioForce	Upper	Lower
.018" x .018"	02-728-042	02-728-542
.020" x .020"	02-728-072	02-728-572



Premium Coated Archwires

Highly durable wires providing great aesthetics and superior sliding mechanics

- Dual coating with a thin inner layer of silver and the outer layer bio-polymer
- More durable compared to other coated wires
- Smooth surface for lower friction
- Natural tooth colour - blends well with all aesthetic brackets
- Resistant to staining



Nickel Titanium

EURO (Pk10)		
Size	Upper	Lower
.014"	HQA-014-00	HQA-014-10
.016"	HQA-016-00	HQA-016-10
.018"	HQA-018-00	HQA-018-10
.016" x .022"	HQA-622-00	HQA-622-10
.018" x .025"	HQA-825-00	HQA-825-10
.019" x .025"	HQA-925-00	HQA-925-10
.020" x .020"	HQA-220-00	HQA-220-10

Stainless Steel

EURO (Pk10)		
Size	Upper	Lower
.018"	HQA-018-05	HQA-018-15
.018" x .025"	HQA-825-05	HQA-825-15
.019" x .025"	HQA-925-05	HQA-925-15

Coated Archwires

Tooth coloured durable coating which blends well with all aesthetic brackets. The size shown is the finished size. Tooth tone coating adds .002" to the diameter. Available in Euro and Full Arch shapes.



NICKEL TITANIUM - EURO (Pk10)		
Size	Upper	Lower
.012"	HQC-012-00	HQC-012-10
.014"	HQC-014-00	HQC-014-10
.016"	HQC-016-00	HQC-016-10
.018"	HQC-018-00	HQC-018-10
.020"	HQC-020-00	HQC-020-10
.016" x .022"	HQC-622-00	HQC-622-10
.017" x .025"	HQC-725-00	HQC-725-10
.018" x .018"	HQC-818-00	HQC-818-10
.018" x .025"	HQC-825-00	HQC-825-10
.019" x .025"	HQC-925-00	HQC-925-10
.020" x .020"	HQC-220-00	HQC-220-10

NICKEL TITANIUM - FULL (Pk10)		
Size	Upper	Lower
.012"	HQC-012-01	HQC-012-11
.014"	HQC-014-01	HQC-014-11
.016"	HQC-016-01	HQC-016-11
.018"	HQC-018-01	HQC-018-11
.020"	HQC-020-01	HQC-020-11
.016" x .022"	HQC-622-01	HQC-622-11
.017" x .025"	HQC-725-01	HQC-725-11
.018" x .018"	HQC-818-01	HQC-818-11
.018" x .025"	HQC-825-01	HQC-825-11
.019" x .025"	HQC-925-01	HQC-925-11
.020" x .020"	HQC-220-01	HQC-220-11

STAINLESSSTEEL - EURO (Pk10)		
Size	Upper	Lower
.014"	HQC-014-50	HQC-014-60
.016"	HQC-016-50	HQC-016-60
.018"	HQC-018-50	HQC-018-60
.020"	HQC-020-50	HQC-020-60
.016" x .022"	HQC-622-50	HQC-622-60
.017" x .025"	HQC-725-50	HQC-725-60
.018" x .018"	HQC-818-50	HQC-818-60
.018" x .025"	HQC-825-50	HQC-825-60
.019" x .025"	HQC-925-50	HQC-925-60

STAINLESSSTEEL - FULL (Pk10)		
Size	Upper	Lower
.014"	HQC-014-51	HQC-014-61
.016"	HQC-016-51	HQC-016-61
.018"	HQC-018-51	HQC-018-61
.020"	HQC-020-51	HQC-020-61
.016" x .022"	HQC-622-51	HQC-622-61
.017" x .025"	HQC-725-51	HQC-725-61
.018" x .018"	HQC-818-51	HQC-818-61
.018" x .025"	HQC-825-51	HQC-825-61
.019" x .025"	HQC-925-51	HQC-925-61



Lingual Archwires

Sentalloy® & NeoSentalloy®

The superior benefits of Sentalloy have now been incorporated into the mushroom arch shape suitable for use with both full lingual treatment and for minor tooth movement. Individually wrapped wires.

Size (Pk10)	Shape	Upper	Lower
.012"	small	O2-911-101	O2-911-601
	medium	O2-911-102	O2-911-602
	large	O2-911-103	O2-911-603
	extra large	O2-911-104	O2-911-604
.014"	small	O2-911-111	O2-911-611
	medium	O2-911-112	O2-911-612
	large	O2-911-113	O2-911-613
	extra large	O2-911-114	O2-911-614
.017" x .025"	small	O2-923-131	O2-923-631
	medium	O2-923-132	O2-923-632
	large	O2-923-133	O2-923-633
	extra large	O2-923-134	O2-923-634

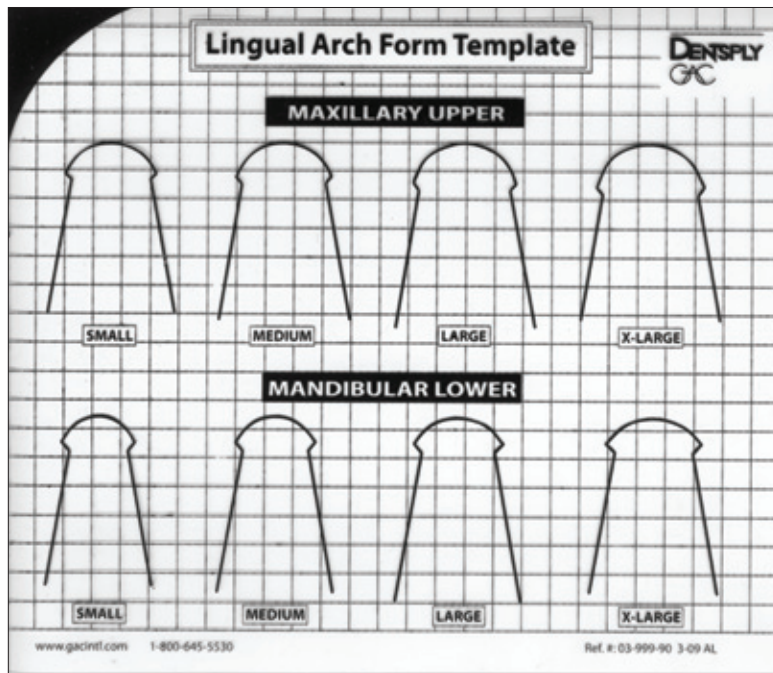

Size (Pk10)	Code
.012" 7" Straight lengths	O2-511-80
.016" 7" Straight lengths	O2-511-82
.018" 7" Straight lengths	O2-511-83

Product	Code
Sentalloy Lingual Arch Form Template	O3-999-90

Resolve® Lingual Universal Wire

This Beta Titanium wire can be bent into a mushroom arch and have step up or down bends placed in it. It can also be used with a closing loop in space closure situations.



Size (Pk10)	Code
.016"	O3-016-00
.016" x .022"	O3-622-000

Chinagraph Markers



Product	Code
Chinagraph Pencil	TOC-CP

Lingual Archwires

A comprehensive range of high quality archwires specifically designed for the demands of lingual treatment.

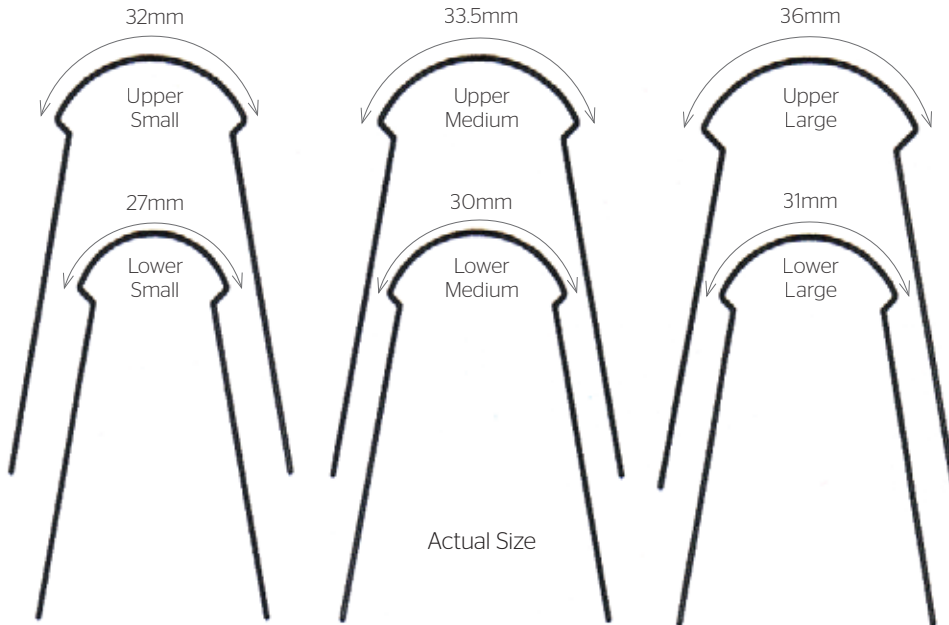

Product	Code
Hi-Q Lingual Arch Form Template	HQ-LAT



Thermal Nickel Titanium

THERMAL NiTi MUSHROOM			
Size	Pk 2	Upper	Lower
.016"	small	HQL-TN-016US	HQL-TN-016LS
	medium	HQL-TN-016UM	HQL-TN-016LM
	large	HQL-TN-016UL	HQL-TN-016LL
.016" x .022"	small	HQL-TN-1622US	HQL-TN-1622LS
	medium	HQL-TN-1622UM	HQL-TN-1622LM
	large	HQL-TN-1622UL	HQL-TN-1622LL
.017" x .017"	small	HQL-TN-1717US	HQL-TN-1717LS
	medium	HQL-TN-1717UM	HQL-TN-1717LM
	large	HQL-TN-1717UL	HQL-TN-1717LL
.017" x .025"	small	HQL-TN-1725US	HQL-TN-1725LS
	medium	HQL-TN-1725UM	HQL-TN-1725LM
	large	HQL-TN-1725UL	HQL-TN-1725LL

Nickel Titanium

NiTi MUSHROOM			
Size	Pk 2	Upper	Lower
.010"	small	HQL-N-010US	HQL-N-010LS
	medium	HQL-N-010UM	HQL-N-010LM
	large	HQL-N-010UL	HQL-N-010LL
.013"	small	HQL-N-013US	HQL-N-013LS
	medium	HQL-N-013UM	HQL-N-013LM
	large	HQL-N-013UL	HQL-N-013LL
.016"	small	HQL-N-016US	HQL-N-016LS
	medium	HQL-N-016UM	HQL-N-016LM
	large	HQL-N-016UL	HQL-N-016LL

Stainless Steel

Available in universal lingual arch form in round and rectangular sizes

STAINLESS STEEL UNIV. (Pk 5)	
Size	U/L
.014"	HQL-SS-014
.016"	HQL-SS-016
.018"	HQL-SS-018
.016" x .022"	HQL-SS-1622

Beta Titanium

Universal lingual arch form

BETA TITANIUM UNIV. (Pk 5)	
Size	U/L
.016"	HQL-B-016
.016" x .022"	HQL-B-1622
.0175" x .0175"	HQL-B-175175

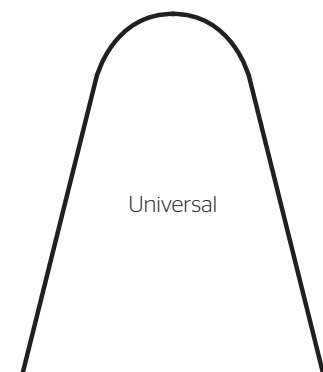

NiTi Sentalloy Closed Coil Springs

DENTSPLY GAC's Sentalloy Coil Springs are body heat activated so they provide more flexibility, greater sizing capability and a superior, near constant force to move teeth without periodontal stress. The closed coil springs have laser fused eyelets for easy engagement and no unwinding.

Closed Coil Springs (Pk 10)	Force	Code
Light	100 grams	10-000-03
Medium	150 grams	10-000-02
Heavy	200 grams	10-000-01

DENTSPLY
GAC



NiTi Closed Coil Springs



- Provides constant force levels for efficient treatment
- Stays active until the space is closed
- Light, gentle forces helps patient comfort
- High quality superelastic NiTi

Closed Coil Springs	Force	Code
.009" x .030" 9mm (Pk 10)	100gm	GC-100-09
.009" x .030" 12mm (Pk 10)	100gm	GC-100-12
.011" x .030" 9mm (Pk 10)	150gm	GC-150-09
.011" x .030" 12mm (Pk 10)	150gm	GC-150-12
.012" x .030" 9mm (Pk 10)	200gm	GC-200-09
.012" x .030" 12mm (Pk 10)	200gm	GC-200-12
21" Spool .030" diameter	-	GC-030-21

NiTi Sentalloy Open Coil Springs

DENTSPLY GAC's Sentalloy Coil Springs deliver a gentle, continuous force to move teeth without periodontal stress. Light constant force offers greater comfort and superior treatment results. Open coils (15mm) may be compressed to 3mm, the coil will exert force until 14mm, then the force falls to 0 as it becomes passive again.

Open Coil Springs	Force	Code
Medium 15mm (Pk 10)	150 grams	10-000-08
Medium 15" Spool	150 grams	10-000-52

DENTSPLY
GAC



NiTi Open Coil Springs

- For the opening or holding of spaces
- Provides consistent, gentle force levels
- High quality superelastic NiTi

NiTi Open Coil Spring Spool

Provides a gentle constant force for opening or holding spaces between teeth.

15" Spool	Code
.010" x .030	03-130-99



DENTSPLY
GAC

Value NiTi Open Coil Springs

Provides a gentle constant force for opening or holding spaces between teeth.



.010" x .030 (Pk 2)	Code
7" length	TOC-OCS

Stainless Steel Coil Springs

Open or Closed wound stainless steel wire designed to hold spaces. 3' per spool.



3' Spool	Code
.010" x .030" Closed	GC-030-10
.010" x .030" Open	GC-030-00
.010" x .036" Open	GC-036-00

Value NiTi Closed Coil Springs

- Close spaces easily for efficient, predictable tooth movement and great patient comfort.
- Strong eyelets easily attached to bracket hooks.



.010" x .030 (Pk 10)	Code
9mm	TOC-9MM
12mm	TOC-12MM

NiTi Distalizing Springs

These stop wound springs distalize molars without having to use headgear. The springs are designed to be easily trimmed to the desired length; just determine the appropriate length and trim the spring in the middle of the closed coil section. You can then place the spring over the archwire and when used in conjunction with an adjustable archwire lock or stop hook, provide the required force for your unique application.

7" Lengths (Pk 3)	Code
.010" x .045"	GD-145-07

Preformed Ligature Ties

- High quality polished stainless steel
- Consistently shaped for a perfect fit under the tie-wing



Size (Pk 1000)	Code
.009"	GL-009-00
.010"	GL-010-00
.012"	GL-012-00

Kobayashi Ties

- High quality polished stainless steel
- Quick placement of auxiliary hook on brackets



Size (Pk 100)	Code
.012"	GK-012-00

Wildcat Wire



Wildcat wire is the most widely used three-strand twist wire in orthodontics. Manufactured from the highest quality stainless steel, it offers superior resilience and it will not unravel when cut to size.

15" Lengths (pk 10)	
Size	Code
.015"	06-150-15
.0175"	06-175-15
.0195"	06-195-15
.0215"	06-215-15



Preformed Shorty Ligature Ties

- High quality polished stainless steel
- Quick and easy engagement



Size (Pk 500)	Code
.010"	GL-010-50

Kobayashi Shorty Ties

- High quality polished stainless steel
- Quick and easy engagement



Size (Pk 100)	Code
.012"	GK-012-50
.014"	GK-014-50

Orthogap®

Disposable Archwire Markers



- Consistent machine dipped wax tips
- Special thick wax tips will not crack or melt
- Precise marking and adhesion to dry metal surfaces
- The attractive dispenser keeps working area organised
- Made with sturdy dowels
- Inexpensive and disposable

Product	Code
Dispenser	600-500
Markers (Pk 100)	600-401

Spooled Ligature Wire

- High quality medical-grade stainless steel from DENTSPLY GAC



.010" 70g Spool	47-505-52
-----------------	-----------

Coated Preformed Ligature Ties

- Tooth coloured for great aesthetics
- Durable plastic coating
- Stainless steel



Size (Pk 100)	Code
.010" (.012" coated)	GL-012-60

Coated Preformed Shorty Ties

- Tooth coloured - blends well with aesthetic brackets
- Durable plastic coating
- Stainless steel

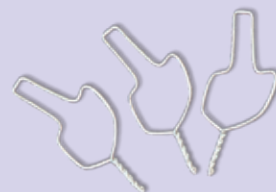

Size (Pk 100)	Code
.010" (.012" coated)	GL-012-61

Coated Kobayashi Shorty Ties

- Tooth coloured for great aesthetics
- Durable plastic coating
- Stainless steel



Size (Pk 100)	Code
.012" (.014" coated)	GK-014-60

Coated NiTi Open Coil Springs

Coated for superior aesthetics with a consistent force level



7" Lengths (Pk 3)	Code
.012" x .030" (.014" x .027" coated)	GC-030-60

BioBiteCorrector[®] MS

A direct and reliable way to Class I Occlusion

New Advanced Design with Pre-mounted Screw

The Bio Bite Corrector (BBC) MS is a fixed rigid inter-maxillary Class II appliance working with the functional principles of the Herbst* appliance.

Indications

- Correction of skeletal Class II malocclusions
- Dentoalveolar correction of Class II malocclusions
- Correction of functional mandibular midline shifts
- Use as an anchorage appliance for closing a gap in the posterior teeth of the lower jaw

The BBC MS can be used for patients lacking compliance, for patients with little growth remaining or for adult patients. Use of the BBC MS can avoid extraction of permanent teeth or even surgical corrections of Class II malocclusions.



BBC MS Pair

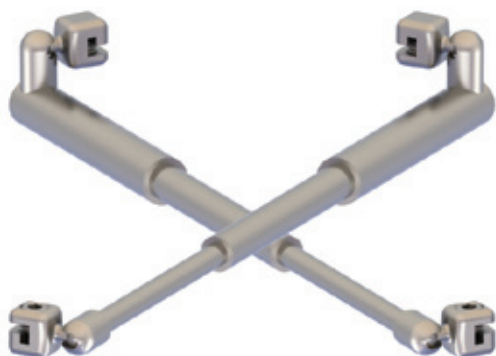

Includes 4 Titanium Fixing screws

Product	Code
BBC MS Standard Pair (non-extraction cases)	205-2015-11
BBC MS Standard Pair (Pk 5)	205-2015-14
BBC MS Standard Pair (Pk 10)	205-2015-15
BBC MS Small Pair (Extraction cases)	205-2015-21

Screwdriver Hex

for Q Screw handle and contra-angled handpiece

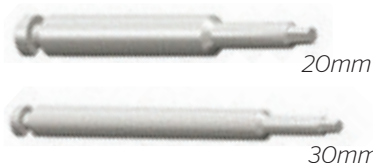

Size	Code
20mm	205-Q2113
30mm	205-Q2113L

Q Screw Handle



Code
205-Q2112

Titanium Fixing Screw



Code (Pk10)
205-2010-44

Torque Ratchet

for Q Screw handle



Code
205-QX30

Titanium Spacer

15mm



Code (Pk 20)
205-2010-33

BBC Attachment

Code (Pk 4)

205-ATC12



BBC MS Right



Includes 2 Titanium Fixing screws

Product	Code
BBC MS Standard Right	205-2015-12
BBC MS Small Right	205-2015-22

BBC MS Left



Includes 2 Titanium Fixing screws

Product	Code
BBC MS Standard Left	205-2015-13
BBC MS Small Left	205-2015-23

BBC MS Starter Kit



Includes: 3 Pairs of BioBite Corrector MS, 20 Titanium Spacers, Q Screw Handle, Screwdriver Hex 20mm

Product	Code
BBC Starter Kit	205-2015-10

ADVANTAGES

DIRECT CLASS I WITH PERFECT AND PRECISE ADJUSTMENT OF THE MANDIBLE:

The BioBiteCorrector MS (BBC) as a passive rigid appliance is able to guide the mandible into bilateral neutral occlusion directly and precisely at any time. By means of c-formed spacers which can be crimped on the telescope bars, the mandible can be protruded precisely and easily.

FUNCTIONAL PRINCIPLE OF THE HERBST-APPLIANCE WITHOUT USING COILSPRINGS:

The BBC MS appliance does not use coilsprings as most other intermaxillary non-compliance Class II appliances do. The BioBiteCorrector works with the functional principles of the Herbst-appliance. Foregoing coilsprings reduces proclination of the lower incisors and uncontrolled forward mandibular movement.

EASY HANDLING:

The BBC is already pre-assembled. You don't have to assemble single parts.

SCREW CONNECTION TO UPPER AND LOWER JAWS:

This connection method to upper and lower jaws ensures a fast and easy fixation of the appliance. The screwable connection is both patient and doctor friendly.

BALL JOINTS:

The ball joints allow lateral movements and sufficient opening of the mouth thus improving comfort. They reduce loading of both the BioBiteCorrector and the bracket system. They also allow a small design of the BBC without causing fatigue of the material or parts of the appliance.

NO BANDS ARE NEEDED:

Unlike other Class II appliances, the BBC does not need bands on the upper molars to be fixed due to its screwable connection.

BIOCOMPATIBLE TITANIUM:

The BBC MS is entirely manufactured of titanium and laser welded. Fixing screws and spacers are manufactured of titanium as well.

DESIGN OF THE SCREW BODY:

The design of the screw body allows an accurate and safe fixation of the appliance. The screw body slides onto the wire via its lateral slot. The fixation of the screw body on the wire is realized by the clamping effect of the screws. The great advantage of the screw body is that it cannot loosen from the wire because of horizontal forces.

*Herbst is the registered trademark of Dentaurum Inc.



**NO
MOLAR
BANDS
NEEDED!**

The torque ratchet can facilitate placement of the BBC MS, with the screwdriver handle being placed in the end of it.

BBC APPLIANCE ON ACTUAL PATIENT

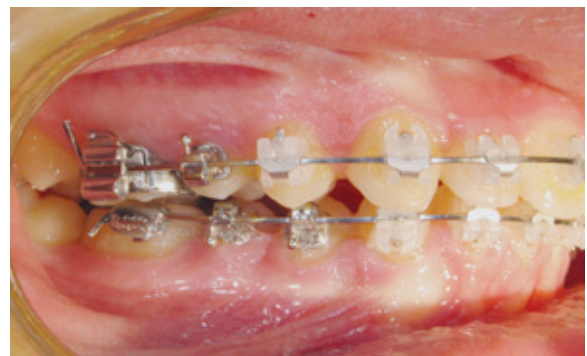

Before placement of BBC



After placement of BBC



Class I after treatment

Eruption Appliances

14k Gold Chain

This superior quality preformed Eruption Appliance helps draw impacted canines into position and it has been a favourite of orthodontists and oral surgeons for many years.

The low profile and positioning of the caplin hook minimises irritation and allows quicker movement. The patented SuperMesh base ensures reliable bonding, particularly with Fuji Ortho LC which is recommended for use in a wet field.

Allergic reactions are minimised because the chain is 14k gold and the button is titanium nitride coated.

After bonding the caplin hook to an impacted tooth, attach an elastic thread to the end of the gold chain. Movement of the tooth is measured by counting the links of the chain as they become exposed.

GAC's strong Square Energy Thread is ideal to use with this Eruption Appliance as the edges eliminate slippage.



Round Flat Base



Eyelet

- Our Dentsply GAC Eruption appliances have been a favourite of orthodontists and oral surgeons for many years
- Corrosion resistant with allergic reactions minimised as the chain is 14k gold and the button is titanium nitride coated



Square Energy Thread is recommended for use with these appliances.

Product	Code
Eruption Appliance, Round Flat Base	17-000-10
Eruption Appliance, Eyelet	17-001-10

Product	Code
Square Energy Thread .025"x.025"	34-666-66

U-Flex™ Eruption Appliance

Can be bonded to any enamel surface of an impacted tooth due to the flexible design of its bondable base. Manufactured with the maximum curvature required for the incisal edge of the incisors but is easily opened out or flattened to fit a gentle curve of a canine crown. Strong, flexible and resistant to corrosion.

The U-FLEX™ Eruption Appliance offers an alternative comfortable, versatile and efficient option for teeth that are impacted at various angles.



Developed by
Dr Russell
Samuels

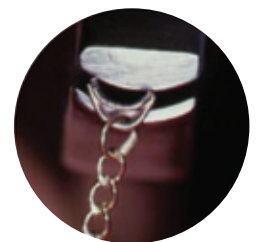
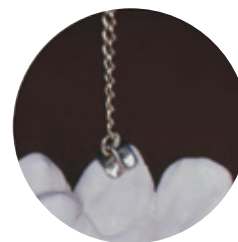
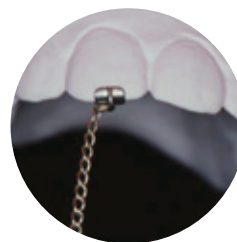

GC Fuji Ortho LC is great for bonding in a wet field See p74



Code
17-100-50

BiteBumper™

Opens deep bite without trauma

Bite-Bumpers work in open and deep bite cases by allowing the anteriors to ride up and out of occlusion without patient trauma. Our Bite-Bumpers eliminate bond failures of brackets and are especially valuable with ceramic or self-ligating brackets.

The unique fixed "placement-jig" guarantees the correct height on the lingual of the tooth and makes sure the two Bite-Bumpers are 100% parallel.



Step 1



Step 2



Step 3

Code (Pk 10)

TOCBB-00-01

BiteBumper is a registered trademark by Gestenco International AB, Sweden

Bondable Buttons Round Base

- One piece
- Round curved base



Code (Pk 10)

JB-400-02

Bondable Eyelets Round Base

- Two piece flat base
- Round base



Code (Pk 10)

JE-025-10

Bondable Caplin Hook



Low profile, low irritation, yet highly functional. The Caplin Hook from DENTSPLY GAC has grown in use every year since its inception over 10 years ago.

Product	Code
For Flat Teeth	30-000-05
For Curved Teeth	30-000-06

Bondable Buttons Rectangle Base

- Rectangular curved base
- One piece base



Code (Pk 10)

JB-400-00

Bondable Eyelets Rectangle Base

- One piece
- Rectangular curved base

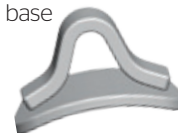

Code (Pk 10)

JE-025-00

Bondable Lingual Cleat

DENTSPLY GAC lingual cleat with a choice of flat or curved base. Available individually.



Product	Code
For Flat Teeth	30-000-02
For Curved Teeth	30-000-03

Bondable Lingual Button

DENTSPLY GAC lingual button with a round base with the option of flat or curved. Available individually.



Product	Code
Flat Base	30-000-00
Curved Base	30-000-01

Bondable Eyelets

DENTSPLY GAC eyelets with a rectangular curved base. Available individually.

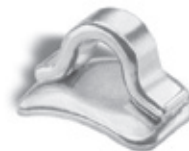

Code
30-000-04

Bondable Composite Buttons

- Aesthetic and stain resistant
- Contoured mechanical base for optimal bonding
- Ideal for use with aligners



Code (Pk 10)
JB-234-00

Bondable Composite Eyelets

- Aesthetic and stain resistant
- Contoured mechanical base for optimal bonding
- Funnelled entry for easy wire insertion

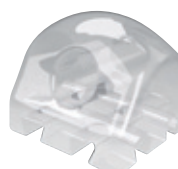

Code (Pk 10)
JB-235-00

For our full range of adhesives see pages 72-75



Crimpable Split Stops

- Can be placed without removing archwire
- Metal injected moulded
- Fits round or rectangular wires
- High quality stainless steel



Code (Pk 20)

47-601-22

Crowder Stops

These are ideal for easy crimping to archwires. The special design of the tube allows quick and sure installation. Crowder stops are excellent to keep wires from rotating out of tubes, for stops with coils and limiting movements between appointments. The .012"/.016" size is for small wires and the .018"/.025" for larger wires.



Product (Pk100)	.012"/.016"	.018"/.025"
2mm	47-602-00	47-602-05
3mm	47-603-00	-

2mm

47-602-00

47-602-05

3mm

47-603-00

-

Crimpable Ball Hooks

- With slide-on archwire opening
- .018" and .022" options available



Size (Pk10)	Code
.018"	JH-018-10
.022"	JH-022-10

.018"

JH-018-10

.022"

JH-022-10

Crimpable Archwire Hooks

- With split archwire opening
- Easy to place without removing the archwire
- Also ideal for use with TADs and mini-screw attachments
- Fits archwires up to .022" x .025"



Right hook (Pk 20)	Left hook (Pk 20)
JH-101-00	JH-101-01

JH-101-00

JH-101-01

Crimpable Ball Hooks

- Place easily without removing the archwire
- Made from high quality stainless steel
- Smooth, rounded hook for patient comfort
- Fits archwires up to .022" x .025"



Code (Pk 20)

JH-121-01

Crimpable Mini Stops

- Mini-size stops with very low profile
- 2mm length
- High quality stainless steel



Product (Pk 25)	Code
Small (for wire sizes .012" to .018")	JS-020-01
Large (for wires .014"x.025" to .019"x.025" & square .020"x.020")	JS-020-02

Small (for wire sizes .012" to .018")

JS-020-01

Large (for wires .014"x.025" to .019"x.025" & square .020"x.020")

JS-020-02

Coated Crimpable Mini Stops

- For a complete aesthetic look
- Slides easily on to the archwire
- Great comfort for the patient
- 2mm in length



Product (Pk 25)	Code
Small (for round wires)	JS-907-01
Large (for square and rectangular wires)	JS-907-02

Small (for round wires)

JS-907-01

Large (for square and rectangular wires)

JS-907-02

Crimpable Bi-Directional Ball Hooks

- Place easily without removing the archwire
- Bi-directional hook for easy ligation
- Smooth, rounded hook for patient comfort
- Fits archwires up to .022 x .025"



Product (Pk 20)	Code
Short (1.6mm)	JH-111-01

Short (1.6mm)

JH-111-01

Coated Crimpable Bi-Directional Ball Hooks

- Great aesthetics
- Non-sliding, strong lock with archwire
- Ball hook can be bent left or right
- Fits round or rectangular archwire up to .018" x .025"
- 4mm length



Code (Pk 10)

JH-907-00

Tongue Tamers®



- Eliminates detrimental forces
- Discourages over-active muscle activity
- Bonds to upper or lower arches
- 80 gauge foil mesh bonding base
- High quality 17-4 stainless steel
- Curved base perfect for lingual placement

Product (Pk 10)	Code
Tongue Tamers	JT-034-00

Tongue Tamers

JT-034-00

Ortho FlexTech™

Gold Chain Retainer Wire

Save on chairtime and lab fees with Ortho FlexTech 14 karat gold chain retainer. Clinically proven, Ortho FlexTech naturally forms to the lingual arch curvature making it easy to fit in the chair. The chain lays flat against the teeth offering improved patient comfort and lasting aesthetics due to its 14 karat gold composition. An etched version is available for improved adhesion.

- Stabilises orthodontic corrections
- Prevents rotational relapses
- Low failure rate due to "flex lineage"



Use with FlowTain™ Light Cure Composite see p76

Product	Code
Gold Chain, 30" Spool	TOC-OFT
Gold Chain Etched, 30" Spool	TOC-OFT-E

Stainless Steel Chain Retainer Wire

An economical version of the gold chain with the same great patented design and ease of use. It offers the added benefits of a 30% increase in tensile strength and 300% increase in torsional strength.



Ortho FlexTech & FlowTain™ Kits



Kit includes: Ortho FlexTech (Gold or Stainless Steel) plus FlowTain Light Cure Flowable Composite

Product	Code
Gold Chain + FlowTain	TOC-OFTKIT
Gold Chain Etched Spool + FlowTain	TOC-OFT-EKIT
Stainless Steel Chain + FlowTain	TOC-OFTSSKIT
FlowTain 1.5gm Syringe + 10 tips	TOC-FT

Product	Code
Stainless Steel Chain, 30" Spool	TOC-OFTSS

Multi-Stranded Retainer Wire

Flattened Multi-Strand Wire in convenient 6" lengths. This is bonded to the lingual surface of the teeth as a permanent fixed retainer once orthodontic treatment has finished.

- No compliance issues
- Long term stability
- Improved patient comfort



Code (Pk 10)
FF-000-06

Bondable Lingual Retainers

Preformed Mesh or Light Cure Base

A full range of lingual retainers including a light cure series of retainers which can be used with any adhesive.

Cuspid to Cuspid

Size (Pk 5)	Mesh Base	Light Cure Base
30mm	48-030-30	48-130-30
31mm	48-030-31	48-130-31
32mm	48-030-32	48-130-32
33mm	48-030-33	48-130-33
34mm	48-030-34	48-130-34
35mm	48-030-35	48-130-35
36mm	48-030-36	48-130-36
37mm	48-030-37	48-130-37
38mm	48-030-38	48-130-38
39mm	48-030-39	48-130-39

Central to Central

Size (Pk 5)	Mesh Base	Light Cure Base
Small	48-001-01	48-101-01
Medium	48-001-02	48-101-02
Wide	48-001-03	48-101-03

Size selection is determined by millimeter measurement from centre of one tooth to the next.



DENTSPLY
GAC

FlowTain is a trademark Reliance Orthodontic Products, Inc.

OSAS

Temporary Anchorage Device

Simple and cost effective

The Orthodontic Skeletal Anchorage System (OSAS) is an easy and uncomplicated system that you can use with confidence. OSAS Screws are extremely stable and highly elastic. Their diameter of 1.6mm with a core of 1.2mm have been proved to be the ideal size for an orthodontic implant and there is a choice of screw lengths between 5mm and 9mm. Larger implants that are available require a greater amount of bone which limits their extensive use.

OSAS screws have the benefit of immediate load bearing. They are self-drilling and self-tapping which facilitates placement and the OSAS offset screw head offers ideal and healthy conditions for the gingiva. All OSAS screws are made of titanium (TiAl6V4), the globally successful, safe and proven material of choice for orthodontic implants.

The OSAS system is manufactured in Germany by Dewimed, a company whose products are sold in nearly 40 countries. As well as orthodontic implants, Dewimed also make General Surgery and Neurosurgery products.

There is no need for complicated strategies. In contrast to conventional implants, OSAS screws are not completely osseointegrated. With the limited duration of orthodontic treatment, osseointegration is unnecessary and unwanted. In fact, the non-integration of the implant makes removal very easy.

Why use any other system?

- All OSAS screws are self-drilling & self-tapping
- Easy and uncomplicated system
- Immediate load bearing
- Ideal size 1.6mm diameter
- One piece manufacture prevents breakage
- Cost effective



Easy application of OSAS screws in just four steps

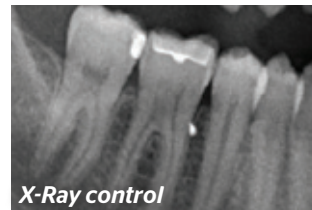

OSAS Screws

All screws sold individually except Training screws (Pk 5)

Cross Hole Screw

This has a closed head with two lots of holes so that the screw is always in a perfect position to place auxiliaries.



Dimensions	Screws	Training (Pk 5)
2.5 x 1.6 x 5mm	25-16125	25-16925T
2.5 x 1.6 x 6mm	25-16126	25-16926T
2.5 x 1.6 x 7mm	25-16127	25-16927T
2.5 x 1.6 x 8mm	25-16128	25-16928T
2.5 x 1.6 x 9mm	25-16129	25-16929T



M.O.S.A.S. Screw

Features an additional plate to prevent the gingiva from growing over the top of it. This makes it easy to remove and is more comfortable for the patient. The MOSAS Screws also have a longer shaft of 2mm which is especially suitable for unattached gingiva.

Dimensions	Screws	Training (Pk 5)
2.5 x 1.6 x 6mm	25M-16206	25M-16906T
2.5 x 1.6 x 7mm	25M-16207	-
2.5 x 1.6 x 8mm	25M-16208	-



Slot Screw

With an open head to allow easy wire insertion from the top of the screw

Dimensions	Screws	Training (Pk 5)
2.5 x 1.6 x 5mm	25-16105	25-16905T
2.5 x 1.6 x 6mm	25-16106	25-16906T
2.5 x 1.6 x 7mm	25-16107	25-16907T
2.5 x 1.6 x 8mm	25-16108	25-16908T
2.5 x 1.6 x 9mm	25-16109	25-16909T



D.O.S. Screw

This new screw has all the same features as the others but with a dome-shaped head which allows for additional elastics or wires to create an additional vector. It enables the tooth to be moved in two directions. The Cross Hole version has two holes and the Plate Screw has one hole and a plate.

Dimensions	Cross Hole Screw	Plate Screw
2.5 x 1.6 x 5mm	25-16145	25-16155
2.5 x 1.6 x 6mm	25-16146	25-16156
2.5 x 1.6 x 7mm	25-16147	25-16157
2.5 x 1.6 x 8mm	25-16148	25-16158
2.5 x 1.6 x 9mm	25-16149	25-16159



Training Screws are great to practice with, but not for use in the mouth

OSAS Introductory Kit

Includes all you need to get started



- OSAS Sterilisation box, Midi (10-0025)
- Universal Screw Driver (10-0014)
- Driver Tip, 40mm (10-0004)
- 1 x Pk 5 Cross Hole Screws (choice of 6, 7 or 8mm)
- OSAS Handbook (00-030-22)



Code
10-1000

Universal Screw Driver

One handle with two uses, as standard for all interventions or mini for palatal interventions.



BEST SELLER

Code
10-0014

Driver Handle, Standard



Code
10-0002

Ratchet Screw Driver, Handle



Code
10-0012

Driver Handle, Short

Mini handle for easy access



Code
10-0003

Teflon Block, for training



Code
00.200.07

Driver Tips



Product	Code
40mm Driver Tip	10-0004
70mm Driver Tip	10-0005

Ratchet Driver Tips



Product	Code
15mm Driver Tip	10-0009
30mm Driver Tip	10-0010

Driver Tips for Contra Angle



Product	Code
5mm Driver Tip	10-0007
10mm Driver Tip	10-0008

Driver Tips for Short Handle



Product	Code
5mm Driver Tip	10-0016
10mm Driver Tip	10-0006

D.O.S. Driver Tips

For use with D.O.S. Screws, this allows a greater view of the working area in restricted spaces.



Product	Code
40mm D.O.S. Driver Tip	10-0040
10mm D.O.S. Driver Tip, for contra handle	10-0042

OSAS Sterilisation Box, Mini

Small, easy and economic



Code
10-0020

OSAS Sterilisation Box, Midi

Standard for the most common applications



BEST SELLER

Code
10-0025

OSAS Sterilisation Box, Large

Complete solution for clearly arranged storage and safe sterilisation of all available instruments.



Code
10-0000

Allergy Control Products

Help minimise allergic reactions to nickel and latex with this comprehensive range of allergy control products

Resolve® Archwires

Premium Nickel Free Wire



DENTSPLY GAC's Resolve Beta Titanium archwires are processed in smaller batches for greater consistency. They are then micro finished for smoother edges and reduced friction, while the long shape offers the ability to make more bends and loops. Resolve contains no nickel that can cause allergic reactions in some patients.

It can be used at any stage of treatment, but it is especially effective where moderate forces are necessary for early torque control and final detailing. High springback and flexibility with lower forces and less breakage make Resolve the new standard in Beta Titanium.

- TiMo Alloy wire
- Nickel free
- Low breakage rate
- Micro finished for smoother finish and lower friction



Beta Titanium

Nickel free wire with a smooth, polished surface to reduce friction

EURO (Pk 10)		
Size	Upper	Lower
.016"	HQB-016-00	HQB-016-10
.018"	HQB-018-00	HQB-018-10
.016" x .016"	HQB-616-00	HQB-616-10
.016" x .022"	HQB-622-00	HQB-622-10
.017" x .025"	HQB-725-00	HQB-725-10
.018" x .018"	HQB-818-00	HQB-818-10
.018" x .025"	HQB-825-00	HQB-825-10
.019" x .025"	HQB-925-00	HQB-925-10
.021" x .025"	HQB-225-00	HQB-225-10

ACCUFORM (FULL)				IDEAL ARCH (EURO)	
Size	Pk 10	Upper	Lower	Upper	Lower
.016"	small	03-016-931	03-016-941	-	-
	medium	03-016-932	03-016-942	-	-
	large	03-016-933	03-016-943	-	-
.018"	small	03-018-931	03-018-941	-	-
	medium	03-018-932	03-018-942	-	-
	large	03-018-933	03-018-943	-	-
.016" x .022"	small	03-622-931	03-622-941	-	-
	medium	03-622-932	03-622-942	03-622-952	03-622-962
	large	03-622-933	03-622-943	-	-
.017" x .025"	small	03-725-931	03-725-941	-	-
	medium	03-725-932	03-725-942	03-725-952	03-725-962
	large	03-725-933	03-725-943	-	-
.018" x .018"	small	03-818-931	03-818-941	-	-
	medium	03-818-932	03-818-942	03-818-952	03-818-962
	large	03-818-933	03-818-943	-	-
.018" x .025"	small	03-825-931	03-825-941	-	-
	medium	03-825-932	03-825-942	03-825-952	03-825-962
	large	03-825-933	03-825-943	-	-
.019" x .025"	small	03-925-931	03-925-941	-	-
	medium	03-925-932	03-925-942	03-925-952	03-925-962
	large	03-925-933	03-925-943	-	-
.021" x .025"	small	03-125-931	03-125-941	-	-
	medium	03-125-932	03-125-942	03-125-952	03-125-962
	large	03-125-933	03-125-943	-	-
.022" x .018"	medium	03-218-932	03-218-942	-	-

FULL (Pk 10)		
Size	Upper	Lower
.016"	HQB-016-01	HQB-016-11
.018"	HQB-018-01	HQB-018-11
.016" x .022"	HQB-622-01	HQB-622-11
.017" x .025"	HQB-725-01	HQB-725-11
.018" x .018"	HQB-818-01	HQB-818-11
.018" x .025"	HQB-825-01	HQB-825-11
.019" x .025"	HQB-925-01	HQB-925-11
.021" x .025"	HQB-225-01	HQB-225-11

UNIVERSAL (Pk 10)	
Size	Upper/Lower
.016" x .025"	HQB-625-55
.017" x .025"	HQB-725-55
.019" x .025"	HQB-925-55



*Roth and MBT prescriptions are not implied to be an exact version of any other system, nor do we claim any endorsement of the Doctors

Nickel Free Brackets

- Metal Injection Moulded (MIM) for quality precision
- Improved sliding mechanics for reduced friction
- Low profile design for patient comfort
- Sandblasted base for reliable bonding and debonding
- Nickel free so safe for all patients

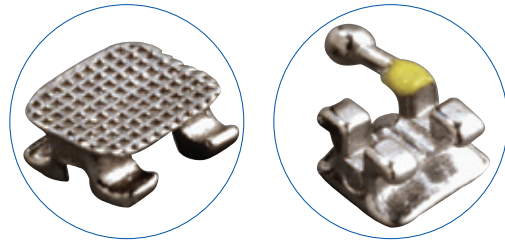

ROTH* .022"	RIGHT	LEFT
U1	NF22-001	NF22-002
U2	NF22-003	NF22-004
U3	NF22-005	NF22-006
U3 + Hook	NF22-007	NF22-008
U4/5	NF22-009	NF22-010
U4/5 + Hook	NF22-011	NF22-012
L1/2	NF22-020	
L3	NF22-021	NF22-022
L3 + Hook	NF22-023	NF22-024
L4	NF22-025	NF22-026
L4 + Hook	NF22-027	NF22-028
L5	NF22-029	NF22-030
L5 + Hook	NF22-031	NF22-032

MBT* .022"	RIGHT	LEFT
U1	NF22-101	NF22-102
U2	NF22-103	NF22-104
U3	NF22-105	NF22-106
U3 + Hook	NF22-107	NF22-108
U4/5	NF22-109	NF22-110
U4/5 + Hook	NF22-111	NF22-112
L1/2	NF22-120	
L3	NF22-121	NF22-122
L3 + Hook	NF22-123	NF22-124
L4	NF22-125	NF22-126
L4 + Hook	NF22-127	NF22-128
L5	NF22-129	NF22-130
L5 + Hook	NF22-131	NF22-132

ROTH .022"	Code
U/L 5-5 + Hooks	NF22-051

MBT .022"	Code
U/L 5-5 + Hooks	NF22-150

**Latex Free
Mighty Ties
& Chain
See p68-69**

**Latex Free
Separators
& Wedges
See p71**

Nickel Free Buccal Tubes

Manufactured using MIM technology for accuracy, these nickel free tubes offer reliable bonding and debonding and are perfect for those patients that are sensitive to nickel.



.022"	
UR6	NF22-061
UL6	NF22-062
RL6	NF22-063
LL6	NF22-064

Latex Free Intra Oral Elastics

TOC's Latex Free Elastics are manufactured from the finest surgical rubber to ensure reliable force delivery and minimise allergic reactions.

- Colour coded bags for easy identification
- Fresh and uncontaminated due to air-tight seal
- Patient bag includes 100 lightly powdered elastics for easy use with no residue
- Packs of 20 patient packs, each containing 100 elastics



Colour (Pk 20)	Force	Size	Latex-free
Rose	3.5oz	3/16"	E35-316LF
Iris	3.5oz	1/4"	E35-14LF
Marigold	4.5oz	1/4"	E45-14LF

Woodland Creatures Latex Free Elastics

- Precision cut to force value
- Clean-cut edges ensure consistent expansion and force
- In-process testing provides consistent force values
- Patient friendly identification system

Size	3/16" (4.8mm)	1/4" (6.4mm)
Medium Force 4.5oz (128g)	Warbler 	Woodpecker
	Code	EW-450-31LF
Heavy Force 6.5oz (184g)	Hedgehog 	Fox
	Code	EW-650-31LF



Premium Elastomerics

High quality ties

Notice the difference with these top quality elastomeric ligatures. Moulded from 100% virgin polyurethane that achieves 90% rebound. This means they fit the bracket better and hold the archwire tighter and longer than competitor ligatures. Yet they have no bulkiness so double ligation can be achieved.

- Excellent stretch and rebound, and will not take a set
- Tear resistant design featuring rounded corners and a flat top provides a strong ligature tie that holds the wire tighter and longer
- The low profile design fits under bracket tie wings and will not irritate the gingiva
- Vibrant colours that resist fading



Sani-Ties®

- Individual patient configuration eliminates potential patient cross contamination
- Available in .110" and .120" diameter sizes
- Packaged in bags of 45 dispensers, 22 ties each stick



Mini-Ties

- Mini Ties contain 10 ties per dispenser, making them truly patient specific
- Allows the use of a unique colour on each arch, without contamination issues or waste
- Available in a .120" diameter size
- Packaged in bags of 100 dispensers, 10 ties each stick



Sili-Ties™

Silicone Impregnated Ties

- Exclusive impregnation reduces friction with wires during treatment
- Injected with a silicone additive that is time-released during the life of the product while in the mouth
- The slick surface makes them easier to place than standard elastomerics - it will not wear off due to abrasion, unlike other coated ties and chain
- Sili-Ties improves aesthetics and retains clarity longer
- .120" diameter size. Ties are packaged in bags of 45 dispensers, 22 ties each



Colour	.110" Ties	.120" Ties	.120" Mini Ties
Amethyst	-	59-600-29	-
Aqua	59-700-11	59-600-11	59-650-11
Black	59-700-02	59-600-02	59-650-02
Blue	59-700-04	59-600-04	59-650-04
Bright Orange	-	59-600-08	-
Bright Pink	59-700-06	59-600-06	-
Clear	59-200-70	59-200-35	59-650-70
Dark Grey	-	-	59-650-71
Emerald	-	59-600-23	59-650-23
Bright Red	-	59-600-54	59-650-54
Fuschia	59-700-24	59-600-24	59-650-24
Glow Clear	-	59-600-33	59-650-33
Glow Blue	-	59-600-36	59-650-36
Glow Green	-	59-600-35	59-650-35
Glow Orange	-	59-600-34	-
Glow Purple	-	59-600-38	-
Glow Pink	-	59-600-37	-
Gold	-	59-600-13	59-650-13
Green	-	59-600-05	59-650-05
Jade	-	59-600-32	-
Jelly Blue	-	59-600-40	-
Jelly Plum	-	59-600-41	-
Jelly Red	59-700-39	59-600-39	-
Lavender	59-700-16	59-600-16	59-650-16
Light Blue	59-700-15	59-600-15	59-650-15
Light Grey	59-100-70	59-100-35	-
Maroon	-	59-600-12	59-650-12
Metallic Black	-	59-600-47	-
Metallic Blue	59-700-18	59-600-18	-
Metallic Purple	-	59-600-48	-
Metallic Red	-	59-600-20	-
Navy Blue	59-700-25	59-600-25	59-650-25
Orange	59-700-50	59-600-50	59-650-50
Pastel Green	59-700-27	59-600-27	-
Pastel Pink	59-700-26	59-600-26	59-650-73
Pastel Yellow	-	-	59-650-74
Pearl-Es	-	50-600-55	59-650-55
Pearl Blue	-	59-600-58	-
Pearl Green	59-700-59	59-600-59	-
Platinum	59-700-30	-	-
Pink	-	59-600-51	59-650-51
Purple	59-700-07	59-600-07	59-650-07
Red	59-700-03	59-600-03	59-650-03
Sapphire	-	59-600-31	-
Silver	59-700-14	59-600-14	59-650-14
Spring Green	59-700-17	59-600-17	59-650-17
Teal	59-700-22	59-600-22	59-650-22
Tooth Colour	-	59-300-35	59-650-20
White	59-700-10	59-600-10	59-650-10
Yellow	59-700-09	59-600-09	59-650-09
Multi Red/Blu/Gre	-	59-600-00	-
Multi Pink/Pur/Ora	-	59-600-01	-

Colour	Code
Clear	59-950-00
Pearlescent	59-950-55
Silver	59-950-03

Mighty Ties™

Great value elastomerics

.115" ligature diameter, with 30 great colours for your patients to choose from!

- 1008 ties per pack (24 per stick)
- Superior elasticity with great recovery
- Excellent colour stability, resistant to fading
- Convenient tabs makes them easy to grip
- High quality medical grade polyurethane
- Latex free minimises allergic reactions



MADE IN USA

Colour	MightyTies™ (Pk1008)	MightyTies™ Mini (Pk1000)
Assorted Colours	EL-120-00	-
Grey	EL-120-01	EM-120-01
Clear	EL-120-02	EM-120-02
Tooth	EL-120-03	EM-120-03
Royal Blue	EL-120-04	EM-120-04
Baby Blue	EL-120-05	EM-120-05
Purple	EL-120-06	EM-120-06
Periwinkle	EL-120-07	EM-120-07
Red	EL-120-08	EM-120-08
Magenta	EL-120-09	EM-120-09
Black	EL-120-10	EM-120-10
White	EL-120-11	EM-120-11
Yellow	EL-120-12	EM-120-12
Baby Pink	EL-120-13	EM-120-13
Aqua	EL-120-14	EM-120-14
Neon Green	EL-120-15	EM-120-15
Kelly Green	EL-120-16	EM-120-16
Emerald	EL-120-17	EM-120-17
Orange	EL-120-18	EM-120-18
Teal	EL-120-19	EM-120-19
Metallic Silver	EL-120-20	EM-120-20
Marigold	EL-120-21	EM-120-21
Fuschia	EL-120-26	EM-120-26
Turquoise	EL-120-27	EM-120-27
Lilac	EL-120-29	EM-120-29
Midnight Blue	EL-120-30	EM-120-30
Sparkle Blue	EL-120-33	EM-120-33
Glow in the Dark	EL-120-50	EM-120-50
Neon Plnk	EL-120-60	EM-120-60
Pearl	EL-120-71	EM-120-71
Carolina Blue	EL-120-72	EM-120-72

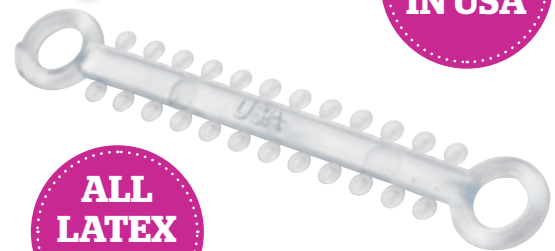

ALL LATEX FREE!

Mighty Ties™ Keyring

A handy keyring for easy selection of Mighty Ties colours



Mighty Ties™	Code
Colour Chart	EL-000-00
Sample keyring (30 sticks)	EL-000-10

Mighty Ties™ Mini

With all the same features of Mighty Ties™ these single patient ties reduce waste and cross contamination.

- 1000 ties per pack (10 ligatures per stick)



Mighty Ties™ Micro

For use with lingual or mini brackets these have a reduced diameter of 0.095"



.095" (Pk1008)	Closed
Silver	EM-095-20

Premium Chain

Super Chain™

- High quality elastic chain
- Provides an optimal and consistent force
- Its super thin profile provides the versatility to piggyback with Sani-Tie Elastomers



Colour (2m Spool)	Short	Medium	Long
Clear	34-012-68	34-013-68	34-011-68
Grey	34-022-68	34-023-68	34-021-68

Sunburst Chain™

- Excellent stretch and rebound, giving superior elongation for easy application
- Short or long size variations
- 15 ft spool



Sili-Chain™

Silicone Impregnated Chain

- Exclusive impregnation reduces friction with wires during treatment
- Injected with a silicone additive that is time-released during the life of the product while in the mouth
- The slick surface makes them easier to place than standard elastomerics - it will not wear off due to abrasion, unlike other coated ties and chain
- Improves aesthetics and retains clarity longer
- 15 ft spools



Colour (15' Spool)	Short	Medium	Long
Clear	59-851-00	59-852-00	59-853-00
Pearlescent	59-851-55	59-852-55	59-853-55
Silver	59-851-03	59-852-03	59-853-03

Colour (15' Spool)	Short Chain	Long Chain
Amethyst	59-200-36	59-300-36
Aqua	59-200-26	59-300-26
Black	59-200-02	59-300-02
Blue	59-200-04	59-300-04
Bright Orange	59-200-08	59-300-08
Bright Pink	59-200-06	59-300-06
Clear	59-200-01	59-300-01
Dark Grey	59-200-09	59-300-09
Emerald	59-200-23	59-300-23
Bright Red	59-200-54	59-300-54
Fuschia	59-200-24	59-300-24
Glow Clear	59-200-32	-
Glow Blue	59-200-11	59-300-11
Glow Green	59-200-33	59-300-33
Glow Orange	59-200-34	59-300-34
Gold	59-200-13	59-300-13
Green	59-200-05	59-300-05
Jade	59-200-39	59-300-39
Jelly Blue	59-200-40	59-300-40
Jelly Plum	59-200-42	59-300-42
Jelly Red	59-200-43	59-300-43
Lavender	59-200-16	59-300-16
Light Blue	59-200-25	59-300-25
Maroon	59-200-12	59-300-12
Metallic Black	59-200-44	59-300-44
Metallic Blue	59-200-18	59-300-18
Metallic Purple	59-200-47	59-300-47
Metallic Red	59-200-20	59-300-20
Navy Blue	59-200-31	59-300-31
Orange	59-200-50	59-300-50
Pastel Green	59-200-30	59-300-30
Pastel Pink	59-200-29	59-300-29
Pearl-Es	59-200-55	59-300-55
Pearl Blue	59-200-58	59-300-58
Platinum	59-200-37	59-300-37
Pink	59-200-51	59-300-51
Purple	59-200-07	59-300-07
Red	59-200-03	59-300-03
Sapphire	59-200-38	59-300-38
Silver	59-200-14	59-300-14
Spring Green	59-200-17	59-300-17
Teal	59-200-22	59-300-22
Tooth Colour	59-200-10	59-300-10
White	59-200-15	59-300-15
Yellow	59-200-27	59-300-27

Mighty Chain™

Great value chain

- Superior elasticity with great recovery
- Excellent colour stability, resistant to fading
- High quality medical grade polyurethane
- Latex free minimises allergic reactions
- 15' spool



Colour (15' Spool)	Closed	Short	Long
Grey	EC-130-01	EC-140-01	EC-150-01
Clear	EC-130-02	EC-140-02	EC-150-02
Tooth	EC-130-03	EC-140-03	EC-150-03
Metallic Silver	EC-130-04	EC-140-04	EC-150-04
Turquoise	EC-130-05	EC-140-05	EC-150-05
Sparkle Blue	EC-130-06	EC-140-06	EC-150-06
Neon Pink	EC-130-07	EC-140-07	EC-150-07
Royal Blue	EC-130-08	EC-140-08	EC-150-08
Red	EC-130-09	EC-140-09	EC-150-09

Elastic Thread

Las-Thread & Las-O-Thread



- Unmatched strength and rebound
- Hollow and solid variations are available for securing knots efficiently
- 25' and 50' spools

Las Thread - Solid	Code
.025" Clear - 25' Spool	34-225-11
.025" Clear - 50' Spool	34-250-11
.025" Grey - 25' Spool	34-225-12
.025" Grey - 50' Spool	34-250-12
.030" Grey - 25' Spool	34-325-12
.030" Clear - 50' Spool	34-350-11
.030" Grey - 50' Spool	34-350-12

Las-O-Thread - Hollow	Code
.025" Clear - 25' Spool	34-225-01
.025" Clear - 50' Spool	34-250-01
.025" Grey - 25' Spool	34-225-02
.025" Grey - 50' Spool	34-250-02
.030" Grey - 25' Spool	34-325-02
.030" Clear - 50' Spool	34-350-02

Ultra Thread

- Unique patented manufacturing process provides a rough surface on the thread
- Knots will not slide or come unravelled during treatment
- A leading elastomeric thread in the market, provides excellent elasticity and memory

DENSPLY
GAC



Size - 25' Spool	Code
.025" Grey	34-425-12
.025" Clear	34-425-11
.030" Grey	34-430-12
.030" Clear	34-430-11

Square Energy Thread

- Edges eliminate slippage with sizing used with V-Slot brackets or any eyelet
- Sturdy, convenient with unequalled memory
- Excellent for use with the Eruption Appliance (see page 58)



Size	Code
.025" x .025"	34-666-66

Great Value Elastomerics!

Bumper Sleeve

Latex free, stain resistant sleeve for archwires.



10' Spool	Code
.018" Grey	EB-018-00
.018" Clear	EB-018-01
.027" Grey	EB-027-00
.027" Clear	EB-027-01

Elastic Thread

- Excellent stretch and rebound.
- Solid and hollow options available



Solid	Code
.020" Grey	ET-020-01
.020" Clear	ET-020-02
.025" Grey	ET-025-01
.025" Clear	ET-025-02
.030" Grey	ET-030-01
.030" Clear	ET-030-02

Hollow	Code
.025" Grey	ET-025-11
.025" Clear	ET-025-12
.030" Grey	ET-030-11
.030" Clear	ET-030-12

Elast-o-Loop™ Separators

- Smooth injection moulded plastic
- Radiopaque and Non-radiopaque
- Latex free

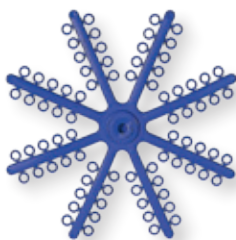

Product (Pk 960)	Code
Blue	ES-300-01
Radiopaque - blue	ES-300-06

Loose Separators

- Smooth injection moulded plastic
- Radiopaque
- Latex free



Colour	Code
Blue (Posterior - Pk 1000)	ES-300-02
Green (Anterior - Pk 100)	ES-300-05

Elast-o-Loop™ Tab Separators

- Lingual and labial tabs to prevent sub-gingival loss
- Easier to remove than other types of separator
- Stronger rebound and memory than radiopaque separators
- Latex free



Product (Pk 960)	Code
Purple	ES-300-00

Rotation Wedges

- Modules fit closely over the bracket tie-wings and stay securely in place
- Wedge shape handle for easy identification and dispensing
- Latex free



Colour (Pk 100)	Code
Grey	EW-300-03
Clear	EW-300-04

Elastic Directors

- Helps your patients place and remove elastics more easily
- Multi-coloured pack



Code (Pk 100)
EP-100-00

Extra-Oral Elastics

- High quality medical grade elastics for extra-oral use
- Provides consistent and accurate force levels

For Facemasks see p86



1/4" (6.4mm) 5/16" (7.9mm) 3/8" (9.4mm) 1/2" (12.7mm)

Size (Pk 1000)	Force	Code
1/4"	16oz	EX-160-14
5/16"	16oz	EX-160-51
3/8"	16oz	EX-160-38
1/2"	16oz	EX-160-12

TOC Intra-Oral Elastics

TOC's Flower Elastics are manufactured from the finest surgical grade natural latex and latex free rubber to ensure reliable force delivery.

- Colour coded bags for easy identification
- Fresh and uncontaminated due to air-tight seal
- Patient bag includes 100 lightly powdered elastics for easy use with no residue
- Packs of 20 patient packs, each containing 100 elastics



Colour coded bags for easy ID

Compare to TP Ortho

Product (Pk 20)	Colour	Force	Size	Latex	Latex-free
Daffodil	Yellow	2oz	5/16"	E20-516	-
Rose	Red	3.5oz	3/16"	E35-316	E35-316LF
Iris	Blue	3.5oz	1/4"	E35-14	E35-14LF
Mint	Green	3.5oz	5/16"	E35-516	-
Fuschia	Pink	3.5oz	3/8"	E35-38	-
Marigold	Orange	4.5oz	1/4"	E45-14	E45-14LF
Thistle	Grey	4.5oz	3/16"	E45-316	-
Honeysuckle	Tan	4.5oz	5/16"	E45-516	-
Heather	Mauve	6oz	5/16"	E60-516	-



Woodland Creatures

Intra-Oral Elastics

- Manufactured using only Surgical Class I Grade natural latex
- Precision cut to force value
- Clean-cut edges ensure consistent expansion and force
- In-process testing provides consistent force values
- Patient friendly identification system
- Supplied in a box of 50 packs containing 100 elastics



Actual size



Size	1/8" (3.2mm)	3/16" (4.8mm)	1/4" (6.4mm)	5/16" (7.9mm)	3/8" (9.5mm)
------	--------------	---------------	--------------	---------------	--------------

Force

	Ant	Beetle	Snail	Butterfly	Frog
Light 2.5oz (71g)					
Natural Latex	EW-250-18	EW-250-31	EW-250-14	EW-250-51	EW-250-38

Force

	Bat	Warbler	Woodpecker	Owl	Hawk
Medium 4.5oz (128g)					
Natural Latex	EW-450-18	EW-450-31	EW-450-14	EW-450-51	EW-450-38
Latex Free	-	EW-450-31LF	EW-450-14LF	-	-

Force

	Mouse	Hedgehog	Fox	Badger	Deer
Heavy 6.5oz (184g)					
Natural Latex	EW-650-18	EW-650-31	EW-650-14	EW-650-51	EW-650-38
Latex Free	-	EW-650-31LF	EW-650-14LF	-	-

Illustrations © Rebecca Pasieka

NeoBond™

Light Cure Bracket Adhesive

Reliable bonding

- Designed to complement LED lights as well as traditional curing lights
- Convenience of a light cure, plus a paste that has the bonding characteristics and viscosity that are optimal for today's mesh bases
- Bonds both chemically and mechanically for a superior bond, while flowing into the tightest mesh without bracket drift
- Fluoride releasing and recharging
- Available in either 4 gm Syringe or 0.4 gm compule delivery system
- Each NeoBond Syringe can be applied to 40-60 brackets

NeoBond Syringe Kit Includes:

2 x 4gm Paste Syringe, 5ml Etch Syringe, 6ml Primer, 25 Mini Mixing Sticks, 25 Gel Etching Tips, 50 Mixing Brushes & Mixing Well

Product	Code
NeoBond Syringe Kit	52-800-00
4gm Paste Syringe	52-800-10
6ml Primer	52-800-11
5ml Gel Etch Syringe & Tips	52-800-16



All trademarks are the property of their respective owners

Intro Kit

Trial this best selling adhesive from DENTSPLY GAC with this handy size kit.

Intro Kit Includes:

2gm Paste Syringe, 2gm Composite Build Up, 2ml Gel Etch Syringe, 2ml Primer, 5 Etch Syringe Tips, 5 Mixing Spatulas & 5 Mini Brushes

Product	Code
NeoBond Intro Kit	52-800-01



Compule Kit

Compule Kit Includes:

20 x 0.4g compules, 5ml Gel Etch Syringe, 25 Etch Tips, 6ml Primer, Compule Gun, 25 Mini Mixing Sticks, 50 Micro Brushes

Product	Code
NeoBond Compule Kit	52-850-00
20 x 0.4gm Compules	52-850-10
GAC Compule Gun	97-400-20



Tru-Grip®

Light Cure Bracket Adhesive Kit

Tru-Grip gives you state-of-the-art technology so you have versatility, ease of handling, aesthetics and reliability at your finger tips. With the ability to bond ceramic, composite and metal brackets and with no bracket drift because of the ideal viscosity, Tru-Grip LC has everything you need in an adhesive. It offers a simple and comfortable application procedure combined with extremely reliable bond strength. Tru-Grip LC provides extended working time to ensure accurate bracket placement and is also a great choice for lingual bonding.



- No mixing required
- Light cure in only 30 seconds
- Ideal viscosity
- Precise placement
- Reliable bond strength

Kit Includes:

15ml Liquid Etch, 7gm Primer, 4 x 5gm Paste Syringes, Spatulas, Mixing Pads, Brush Holder, Brushes



Product	Code
Light Cure Bracket Adhesive Kit	TG-100-00
Light Cure Bracket Adhesive Trial Kit	TG-100-10
Light Cure Syringe Bracket Adhesive Paste, 5gm	TG-100-20
Light Cure Adhesive Primer, 16ml	TG-100-30

Trial Kit Includes:

6gm Liquid Etch, 3ml Primer, 1 x 5gm Paste Syringe, Spatulas, Long Handle Brushes

Tru-Grip® No-Mix Adhesive Kit

Tru-Grip No-Mix Bracket adhesive gives you the convenience and security of virtually unlimited working time. Tru-Grip reduces the possibility of errors and eliminates the problems found in other self-cure adhesives and the ideal viscosity means no annoying bracket drift. Application is extremely simple and fast resulting in substantial chair-time savings. Delayed cure allows correct positioning of brackets up to 20 seconds after original placement. Brackets are ready for archwire insertion only 4 minutes after placement.

- Long working time
- Simple and fast application
- Chair time savings

Kit Includes:

16ml Primer, 9gm Liquid Etch, 3 x 5gm Paste Syringes, Mixing Pads, Spatulas, Long Handle Brushes



Trial Kit Includes:

6ml Primer, 6gm Liquid Etch, 1 x 5gm Paste Syringe, Spatulas, Long Handle Brushes

Product	Code
No-Mix Adhesive Kit	TG-200-00
No-Mix Adhesive Trial Kit	TG-200-10
No-Mix Adhesive Paste syringe, 5gm	TG-200-20
No-Mix Adhesive Primer, 16ml	TG-200-30



Bulk Gel Etch Kit

Phosphoric Acid Gel in a luer lock syringe. Green colour for visual confirmation of application and rinsing. Luer lock tips are angled for easy access and better control.

Kit Includes:

60g Gel Etch, 5 empty 3ml Syringes, Luer Lock Applicator Tips

Product	Code
Gel Etch Kit	BULKETCH
Etch Tips (Pk 100)	TOCFBG270



Liquid Etch

A thin consistency etch used to make enamel and dentin susceptible to bonding. It conditions the tooth to enhance adhesion and mechanical retention.

- 37% Phosphoric acid
- Green colour
- Viscosity similar to water
- 30ml (1fl oz) per bottle



Code
506107

Adhesive Primer Light Cure

Prepares etched enamel ready for bonding.

- Easy to use
- Trusted reliability
- For use with metal, plastic and ceramic brackets
- Ensures consistent bond strength



Product	Code
Adhesive Primer Light Cure, 7gm	TG-100-30

Porcelain Primer

For preparing porcelain crowns and veneers before bonding brackets.

Used in addition to orthodontic adhesive primers.



Product	Code
Porcelain Primer, 15ml	TOCPP

Fuji Ortho™ Light Cure Bracket Adhesive

Bonds perfectly in a wet field

Now you can work faster and easier; and get all the strength needed, with little chance of decalcification (white spots) and enamel damage at debonding. A continual fluoride release promotes remineralisation and helps maintain the soundness of the enamel.

- Clinically proven. Fuji Ortho LC offers significant advantages over composite bonding systems and greatly reduces chairtime.
- Low sensitivity to moisture and can be used in the presence of saliva.
- Bonds metal and porcelain brackets and metal bands to enamel.

Kit Includes:

15gm Powder, 6.8ml Liquid, Scoop and Mixing Pad

Product	Code
Light Cure Intro Kit	TOC000027
Conditioner, 23.8ml	TOC001820
Powder, 40gm	TOC000029
Liquid, 6.8ml	TOC000030



Fuji Ortho™ Light Cure Capsules

Kit Includes:

50 Capsules, 0.30g Powder, 0.10g Liquid per Capsule

Product	Code
Light Cure Capsules Refill	TOC000034
Capsule Applicator	TOC800120
Conditioner, 23.8ml	TOC001820



NeoBand™ Light Cure Band Cement

DENSPY
GAC

- Excellent flow for filling gap between band & tooth
- Properties allow for optimal covering of the surface of the band and tooth
- Easy to identify - blue colour
- Fluoride releasing
- Very low water absorption - lower than 40 microgram/mm3
- Very low solubility - lower than 7.5 microgram/mm3
- Even adhesion & easy to remove
- May also be used for adjusting occlusion to prevent deep bite & occlusal interference



See
p34-36 for
our range
of bands

Product	Code
1 x 4gm syringes	52-800-51
6 x 4gm syringes	52-800-52

Each NeoBand Syringe can be applied to 20-25 bands.

TruGrip® Light Cure Band Cement

Tru-Grip Light Cure Orthodontic Band Cement requires no mixing and provides all the working time you want together with consistent performance. Acid etching isn't necessary and curing is possible in 20 seconds with a high performance curing light. The syringe gives easy and accurate delivery of the cement reducing waste and the distinctive blue colour makes for easy clean up.

- Acid etching not necessary
- No-mixing so less waste
- Cures on demand
- High bond strength
- Contains fluoride



Product	Code
Light Cure Band Cement Kit, 6 x 5gm syringes	TG-400-00
Light Cure Band Cement syringe	TG-400-20

TruGrip® Glass Ionomer Band Cement Kit



Tru-Grip Glass Ionomer Band Cement is an impressive caries-preventive cement. Tru-Grip chemically bonds to dentin and metal, and helps prevent breakdown or loss of enamel. This is an excellent orthodontic band cement with the added bonus of fluoride release reducing the risk of decalcification.

- Reliable bond strength
- Fluoride releasing
- Easy to use



Kit Includes:
15ml Liquid,
15gm Powder, Scoop

Code
TG-300-00

FlowTain™

Flowable Light Cure Composite

FlowTain's low viscosity makes it ideal for bonding lingual retainers, splinting materials and indirect bonding of brackets. It is very smooth when cured which will reduce wear and enhance patient comfort.

For use with Ortho FlexTech see p61



- Flowable viscosity - even though FlowTain is a flowable material, it's thixotropic properties prevents it from slumping for better control
- Cured composite flexibility - when cured FlowTain has a low modulus of elasticity and is not as brittle as conventional composites
- Needle tip dispenser - using the tips provided, FlowTain is easily injected onto lingual surfaces and across fibre splints

Product	Code
1.5gm syringe, 10 tips	TOC-FT
Gold Ortho FlexTech spool & FlowTain	TOC-OFTKIT
Stainless Steel Ortho FlexTech spool & FlowTain	TOC-OFTSSKIT

Flowable Composite

Flowable Composite is a radiopaque fluoride containing a light cure resin-based micro-hybrid flowable composite. The specially formulated material incorporates both a nano-sized filler for increased flexibility and superior polishability with a larger sized filler for excellent strength and wear resistance.

This special combination provides a material with extreme versatility for use in a wide range of procedures.



Kit Includes:

4 x 1.5gm Flowable Composite Syringes

Product	Code
Flowable Composite Kit	TG-100-50
1.5gm syringe + 5 applicator tips	TG-100-60



Starlight Pro Cordless LED Curing Light see p84

Setting up a Laboaratory?

TOC can supply everything you need for your orthodontic laboratory



See our website www.toclaboratory.com or phone us on our dedicated **Lab Line - 0117 907 5558** to receive our latest Special Offer Flyer & Catalogue



Bonding Accessories

Disposable Bonding Pads

Combination mixing pad and bonding pad, saves you time and money!

- Adhesive backing holds brackets firmly in place
- Liquid impermeable surface for mixing
- Easy bracket access speeds selection
- Padded for easy dispensing



Product (25 sheets)	Code
Bonding Pads	LB-300-01



Dimensions

6¼" W x 6¾" H x 4¼" D

Product	Code
Bonding Pad Organiser	LB-300-00

Mixing Pads

- Liquid impermeable surface
- Smooth finished surface



Product (50 sheet pads)	Code
3" x 5" x 3"	600-610

Sponge Pellets

- Great way to apply etch
- Ideal for applying primer
- Help conserve material



Product (Pk 200)	Code
Sponge Pellets	LP-004-00

Bonding Brushes

- Injection molded plastic handle
- ¼" stem with ½" tuft
- Use for sealant or primers



Product	Code
Tip Holder	FN-PLAS-133
Brush Tips ¾" (Pk 100)	FN-PLAS-048

- 2" disposable bonding brush

Product	Code
Pack 400	610-100
Pack 50	610-100S



Plastic Bonding Trays

- With or without mixing wells
- Adhesive holds brackets in place
- Holds one full bracket set-up with buccal tubes

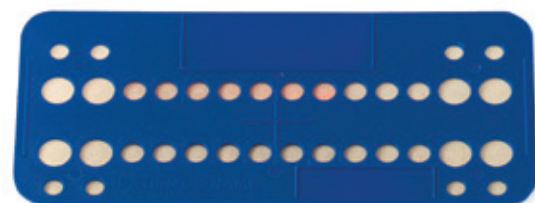

Product	Code
With mixing wells	LT-350-00
Without mixing wells	LT-355-00

Microbrush[®] Original

Tube Series - Regular tip



- Precise placement of solutions
- Reduces use of excess solutions
- Bends easily into any angle
- Non-linting and non-absorbent tips
- Colour coding avoids application mix-up

Product	Code
Pack 400	LB-400-00

Aluminium Oxide

For achieving efficient cleaning and polishing

For removal of resins, cements and composites with no enamel erosion.

- Intraoral applications - 50 micron, white
- Extraoral applications - 90 micron, tan
- Great for use with Micro Etcher



Product	Code
50 micron, 454 gm - White	LA-100-01
90 micron, 454 gm - Tan	LA-100-02

Pre-Mixed Prophy Paste

- Cleans teeth prior to bonding without leaving any residue
- No fluoride, flavouring or oils
- Enhances bond strength
- Supplied in convenient single unit cups to minimise waste
- Each pack contains 200 cups and 1 holder



Product	Code
200 x 2gm pots	LP-200-00

Dust Inn 2000

Compact, Lightweight and Attractive

The Dust-Inn 2000 is a compact, lightweight and attractive dust collector. The unit is fitted with a quiet, efficient fan extractor system, with easy-to-replace filters. Spent abrasive particles collect beneath the perforated work table for simple disposal.

- Ideal for collecting spent grit and abrasive
- For use with all Miniblasters[™] or Microetchers[™]
- New aesthetic design offers more ergonomic features
- Efficient 12-volt filtered extraction system
- Ideal for lab work or chair side use
- Vision-Dome and filters can be easily replaced
- 12.5" (31.8cm) diameter



Code
2039-013

MacroCab+

Self-contained Dust Unit

Compact and modern, this unit offers an efficient and comfortable design where you only insert your fingers with handpiece to work. Bright, LED lights provide ideal illumination.

- Built in dust collection / filtration system
- Easy to clean
- Filter lasts for years
- Quiet
- Heavy gauge aluminium
- Anodized finish

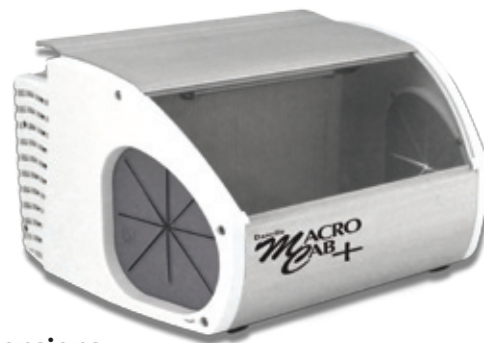

Dimensions
192.5mm H x 312.5mm W x 262.5mm D

Code
TOC-91740

Microetcher™

Intra Oral Sandblaster

Benefits

- Increases bond strength up to 400%
- Stainless construction and replaceable carbide tip
- Nozzle rotates 360° for easy access

Uses

- Etch all metals, composites and amalgam
- Perfect for adhesive removal for rebonds or for etching the inside of bands
- Surface abrasion procedures in seconds

Fully Autoclavable

Handpiece, 2 abrasive reservoirs, air line and user guide. Autoclavable up to 269°F/132°C. Plastic jar and tubing must be removed and abrasive jar filter removal recommended prior to sterilisation

Foil Mesh Bracket Base

Before Microetcher II After Microetcher II

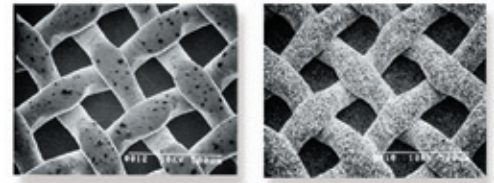

Product	Code
MicroEtcher IIA	22005

60° autoclavable nozzle, 2 abrasive reservoirs, air line and user guide

Product	Code
MicroEtcher II	22000



1 male quick disconnect, 1 female quick disconnect, 1 tee connector and 2 tube connectors

Product	Code
Quick Disconnect Kit	44000



1 female quick disconnect, tee connector and 2 tube connectors

Product	Code
Female Disconnect Kit	44010



Product	Code
Male Disconnect	44020



Product	Code
Handpiece Adapter	44075

Mini-Mold™ TECHNIQUE

Light cure your own aesthetic attachments
IN SECONDS!

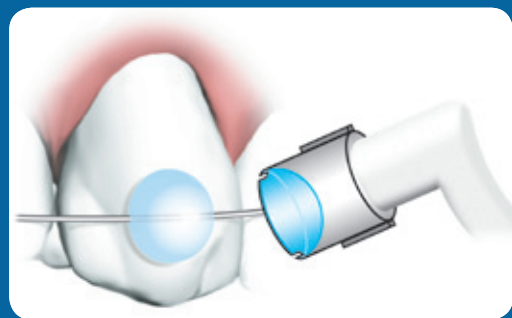

FILL the selected Mini-Mold Tip with light cure resin



PLACE the Mini-Mold Tip on desired tooth



LIGHT CURE the Mini-Mold Tip for 10 seconds

First Time Order?

Try our Starter Kit, it's a great way to sample every style of Mini-Mold.



Starter Kit Includes

27 Tips, 3 of each style, 2 tip handles and detailed step-by-step instructions.

Code

51399

Mini-Mold Tips

Choose from 7 different Mini-Mold Treatment Tips. Available as a pack of 10 or 8 tips, 1 tip handle and detailed step by step instructions. Cold sterilisable.



Posterior Molar Pad Tips
Designed to open the bite from the posterior teeth.

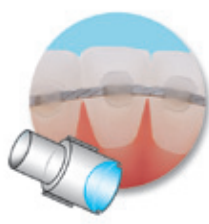

Wire Bonder Tips
Ideal for making direct bond lingual retainers. Comes in large and small sizes.



Bite-Ramp Tips
Creates a bite-opening ramp on the lingual of the upper anterior teeth.



Button Tips
Creates a functional low profile button quickly and easily.



Tube Tips
Designed to create a temporary tube.



Habit-Control Tips
The small, conical spike ends thumb sucking and tongue thrusting.



Bracket Tips
Creates edgewise brackets, ideal for minor tooth adjustments.

Type of Tips	Code
Bite Ramp 5mm (Pk 8)	51389
Posterior Molar pad (Pk 10)	51390
Tube (Pk 10)	51391
Bite Ramp 3mm (Pk 8)	51392
Wire Bonder 4.5mm (Pk 10)	51393
Button (Pk 10)	51394
Habit Control (Pk 10)	51395
Bracket (Pk 10)	51396
Wire Bonder 3mm (Pk 10)	51397
Spare Handle	FN-PLAS133

Nola Dry Field System

For complete bonding success

The Nola Dry Field System completely eliminates saliva and fully exposes both arches making it ideal for all bonding applications.

The system is easy to assemble and can be inserted and used by a single operator. The entire system is completely autoclavable to 280°F/135°C.

- Saves chair time
- Reduces rebonding
- Prevents treatment delays
- Maximum access

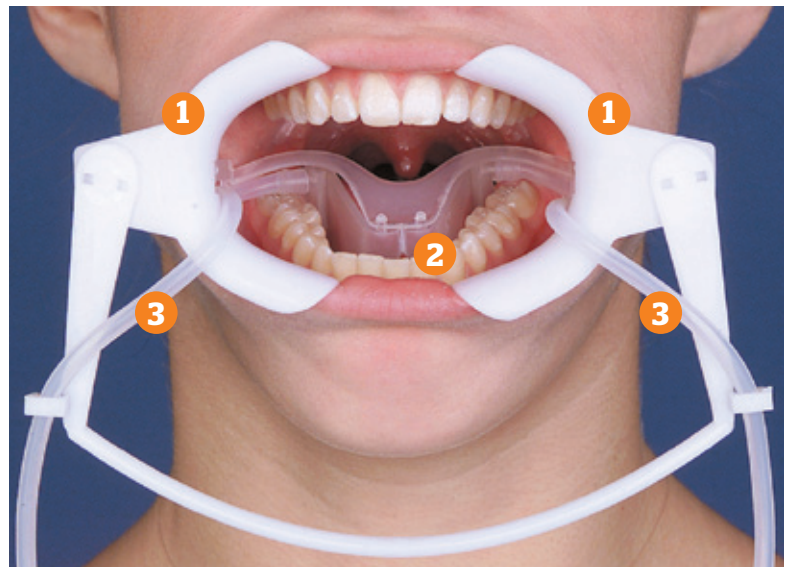

1. Adjustable Cheek Retractor

Keeps the cheeks back and fully exposes both arches. Adjust to arch length.

2. Tongue Guard

Holds the tongue in place and allows the patient to continue swallowing

3. Low or High Volume Bilateral Silicone Tubing

Precisely directs saliva flow and ensures unrestricted evacuation for a totally dry environment

4. Central Suction

"Y" connector adapter (low-volume and high-volume also available)



Separate Components

Cheek Retractor

Assembly with flexible connector



Low-Volume Adapters

4 Adapters and 4 "Y" connectors



High-Volume Adapters

4 Adapters and 4 "Y" connectors



Tongue Guards



"Y" Connector



Connecting Arm Inserts

Used for connecting Tongue Guards to Cheek Retractor.



Bilateral Suction Tubes

Silicone Tubing



System Kit includes:

1 cheek retractor, 1 flexible connector, 1 tongue guard, 2 bilateral suction tubes, 1 central suction "Y" connector with low-volume adapter

Product	Code
Nola Dry Field System Kit - Small (Red)	LN-400-00
Nola Dry Field System Kit - Large (White)	LN-400-01
Connecting Arm Inserts	LN-400-02
Tongue Guards - Large (White)	LN-400-03
Cheek Retractor - Large (White)	LN-400-06
"Y" Connector	LN-400-08
Low-Volume Adapters	LN-400-09
High-Volume Adapters	LN-400-11
Bilateral Suction Tubes	LN-400-12
Tongue Guards - Small (Red)	LN-400-13
Cheek Retractor - Small (Red)	LN-400-14

Extraoral Cheek Retractors

- Provides a full view and easy access for bonding
- Cold Sterilisable
- Pack of 2



Product	Code
Pedo	LC-300-20
Teen	LC-300-21
Adult	LC-300-22

Intraoral Cheek Retractors

- Allows maximum access to the whole mouth
- Disposable and autoclavable options



Autoclavable	Code	Disposable (Pk 10)	Code
Pedo	LC-300-01	Pedo (Green)	LC-200-01
Teen	LC-300-02	Teen (Blue)	LC-200-02
Adult	LC-300-03	Adult (Red)	LC-200-03

Extraoral Cheek Retractors

- Provides a full view and easy access for bonding
- Strong one piece design



Sterilisable up to 370°F/188°C

Product	Code
Pedo	LC-100-01
Adult	LC-100-02

Lip Ring Retractor

- Great for bonding and intraoral photography
- Can also be used to protect lips during interproximal stripping
- Made of high quality medical grade plastic
- Cold Sterilisable
- Pack of 2



Code
LR-400-02

High Heat Cheek Retractor

Easy to use, this High Heat Cheek Retractor provides superior intraoral access for bonding and other procedures. The unique buccal extensions retract powerful buccinator muscles to provide an unobstructed view. Made from medical grade materials that withstand repeated sterilisation. One size fits all.



- Provides an unobstructed view with superior buccal access
- Autoclavable and dry heat sterilisable up to 350°F/177°C
- Comfortable for the patient
- Easy tension control
- Increased visibility to work areas

Provides maximum access

Product	Code
High Heat	LC-400-01

Double Ended Photo Cheek Retractors



- Brushed stainless steel to reduce glare
- Double-ended with a different size on each end for adult and child
- Longer lasting compared to plastic retractors

Sterilisable up to 320°F/160°C

Product (Pk 2)	Code
Brushed Stainless Steel	LR-159-00

Double Ended Photo Cheek Retractors



- Sturdy plastic will not crack
- Double ended for adult and child sizes
- Smooth with rounded edges for patient comfort

Autoclavable up to 250°F/121°C

Code (Pk 2)
LR-155-00

Double Ended Photo Cheek Retractors



- Smooth comfortable edges
- Double-ended with a different size on each end for adult and child

Autoclavable up to 270°F/132°C

Product (Pk 2)	Code
Autoclavable	QC-400-01
Product (Pk 2)	Code
Heat Sterilisable	QC-400-02

Optragate® Extra Soft Lip and Cheek Retractor

Optragate ExtraSoft is flexible and elastic allowing unimpeded jaw movements during the entire procedure. Latex free so is suitable for use with latex allergic patients and staff.



- Single use
- Improved patient comfort
- Full view of oral cavity

Product (Pk 80)	Code
Assorted	TOC577275
Junior	TOC591451
Regular	TOC590850
Small	TOC590851

Long-Handled Photo Cheek Retractors

- Strong, clear plastic
- Comfortable with smooth edges
- Adult and child sizes



Product (Pk 2)	Code
Small	QC-300-01
Large	QC-300-02

Autoclavable up to 270°F/132°C

Evacu Cheek Retractor

The Evacu evacuation and cheek retractor is used in conjunction with high volume evacuation to ensure a moisture free field during bonding, with less need for chair side assistance.



Autoclavable up to 230°F/110°C

Code
TOCEV-00-01

Cheek Retractor

The longer extension tabs allow the cheeks to be pulled back further providing maximum access for easier photography.



Autoclavable up to 230°F/110°C

Code
TOCCR-00-01

Retract-EEZ® Photo Lip Retractor

- Allows unrestricted access
- Perfect for occlusal photographs and quick direct bond repair
- Extremely comfortable for patients
- Angled head retracts lips
- One size fits most

Code (Each)
QL-500-01



STARLIGHT PRO

Cordless LED Curing Light

LIGHTWEIGHT, POWERFUL AND VERSATILE

The very latest Starlight Pro LED Curing Light is ultra light, practical and easy to use as well as extraordinarily ergonomic.

Thanks to its high performance and the long-lasting lithium-ion battery, it will run for 400 cycles and recharging takes only 90 minutes.

CHARGING STATION

- Green control LEDs indicating mains supply, signals charging process and power output
- A yellow LED flashing warning light
- Integrated radiometer which checks the power output
- Result indicated by a LED

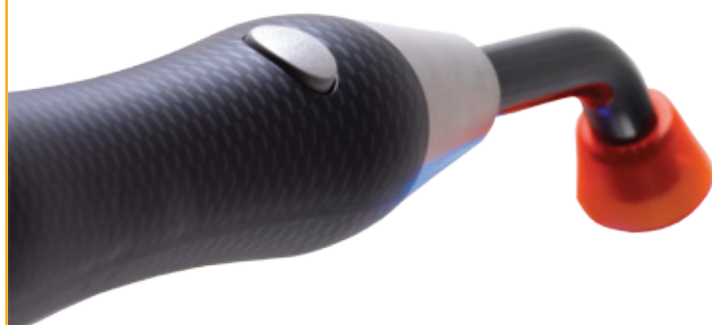

Technical Specifications:

198mm x 22.5mm; 105g; 5W LED with patented optical focusing; Wavelength range - 440-480nm with peak at 460nm; Working life of LED - 2.500.00 cycles, 10 secs each; Battery capacity 400 cycles.

Product (Colour)	Code
Shiny White	LS-051-83
Shiny Yellow	LS-051-85
Matt Black	LS-051-86
Silver	LS-051-87

Fibre Optic Starlight Pro Tip

A replacement tip for the Starlight Pro.



Code

TOCIS02750004

Safety Glasses

For use with all Curing Lights

- Coated lenses for superior scratch resistance
- Orange lens - increases contrast and enhances low light image resolution
- Exceeds ANSI Z871 - 2003 High Impact requirements / Exceeds CSA Z94.3 standards
- Integrated nose piece
- Lenses give 99% UV protection



Code

TOC-SG

Barrier Sleeves

These barrier sleeves will help protect from cross contamination. For use with curing lights.

Product (Pk 1000)

Sleeves

Code

TOCSLEEVE

Curing Light Shield Paddle Type

Code (Pk 2)

TOCFXS015



Curing Light Shield

Code (Pk 2)

TOCIS02900018





Ideal Smile[®] ALIGNER

— FOR MINOR TOOTH MOVEMENT —

DENTSPLY
GAC

The aligner with a difference!

NEW *Ideal Smile*[®] **ALIGNER** from Dentsply GAC is the perfect solution for your adult patients who require a quick, aesthetic treatment for their minor misalignments.

Ideal Smile[®] **ALIGNER** leaves clinical control up to you, while you take full advantage of the latest in treatment technology.

Ideal Smile[®] **ALIGNER** is an online prescription platform with proprietary digital modelling, a 3D setup and full laboratory service. With several advantages over other aligner systems, *Ideal Smile*[®] **ALIGNER** provides a complete solution dedicated to your treatment success.

Offer your patients a clear reason to smile by integrating *Ideal Smile*[®] **ALIGNER** into your practice.

WHAT'S DIFFERENT

- ✓ Truly Aesthetic with NO Elastics or Attachments
- ✓ Clinically Proven Method Based on 'Points of Force' Technique
- ✓ Complete Laboratory Service
- ✓ One Fixed Price Per Patient
- ✓ Precise Treatment

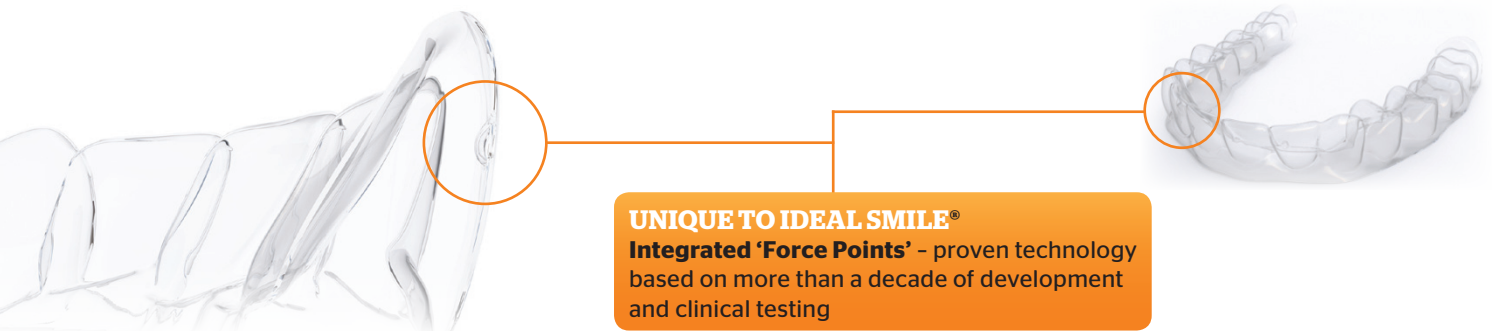

Make an appointment with your TOC Business Development Executive today to begin treating with *Ideal Smile*[®] **ALIGNER**.

Comfort Fit Facemask

For Maximum Class III Compliance

Constructed of stainless steel and unbreakable plastic. The single vertical spindle is ideal for maximum patient comfort and easy fit adjustment. Comfort Fit Facemasks are available in three colours. Each includes an adjustment wrench and replacement comfort pads.

- Made of Stainless Steel and unbreakable plastic
- Great patient comfort
- Centrally located design to aid sleep
- Easy fit and adjustment
- Light-weight
- Fully-Adjustable for any patient
- Screws designed for increased durability

1. Ergonomic Forehead Rest

High impact moulded plastic for a smooth aesthetic appearance. Replaceable medical-grade foam cushion. Fully-adjustable with hexagon key.

2. Durable Screws

Designed to reduce the likelihood of screw stripping and increase durability.

3. Forehead Rest with Dual Free-Flow Air Vents

Allows air to flow under foam padding for maximum patient comfort.

4. Vertical Main Frame

Formed from the highest quality corrosion resistant stainless steel. Flat surface prevents rotation of parts.

5. Horizontal Crossbar

Multi-Adjustable for precise angle of force delivery. Multiple elastic stops eliminate slippage. Moulded plastic with metal reinforced centre for strength.

6. Ergonomic Chin Cup

High impact moulded plastic for a smooth aesthetic appearance. Replaceable medical-grade foam cushion. Fully-adjustable with hexagon key.

7. Streamlined Design with Full Range of Motion Option

Smaller area for more even pressure distribution for different facial structures. The set-screw gives the option for a fixed position or for full range of motion. Glides smoothly along the mainframe without side-to-side rotation. Allows the patient to open and close their mouth comfortably with a full range of movement.

8. Chin Cup with Free-Flow Air Vent

Allows air to flow under foam padding for maximum patient comfort. Chin cup with improved ergonomic design. Less pressure applied to tissue area of lower incisors.

9. Small Light-Weight End Caps

Smooth aesthetic appearance.

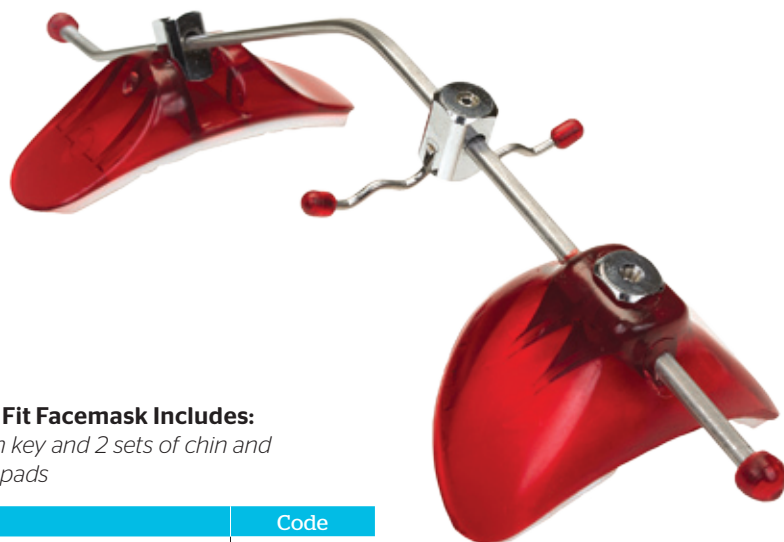

Comfort Fit Facemask Includes:

1 hexagon key and 2 sets of chin and forehead pads

Product	Code
Facemask - Blue	XH-400-02
Facemask - Red	XH-400-03
Facemask - Clear	XH-400-04
Replacement Pads (1 Chin/1 Forehead)	XH-400-00

Extra-Oral Elastics

- High quality medical grade elastics for extra-oral use
- Provides consistent and accurate force levels

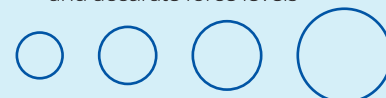

1/4" (6.4mm) 5/16" (7.9mm) 3/8" (9.4mm) 1/2" (12.7mm)

Size (Pk 1000)	Weight	Code
1/4"	16oz	EX-160-14
5/16"	16oz	EX-160-51
3/8"	16oz	EX-160-38
1/2"	16oz	EX-160-12



Cotton Cervical Neckpads

- Poly/cotton blend
- Sturdy washable design
- Two hook-up tabs
- Bright, fun and stylish colours
- Increase patient compliance
- Use with any style module

Colour (Pk 5)	Code
Assorted	550-500



Cotton Cervical Neckpads

- Poly/cotton blend
- Sturdy washable design
- Two hook-up tabs
- Use with any style module

Colour (Pk 5)	Code
Royal Blue	550-200



Cotton High Pull Head Caps

- Poly/cotton blend
- Sturdy washable design
- Two hook-up tabs
- Use with any style module

Colour (Pk 5)	Code
Royal Blue	550-750

Steel C-Clamp with Safety Release Module



- Flexible tear-proof strap
- Durable steel clamp design
- Attaches to any neckpad
- Large facebow holes
- Safety release

Product (Pk10)	Code
600gm Medium	550-110

Ideal Lip Bumpers



- Provides greater patient comfort while allowing easier height adjustment
- Translucent colour
- Maximum adjustability
- For .045" tubes

Product	Code
Size 0 - 72mm	09-045-30
Size 1 - 76mm	09-045-31
Size 2 - 80mm	09-045-32
Size 3 - 84mm	09-045-33
Size 4 - 88mm	09-045-34

Nitom² Locking Facebows

- The Nitom locks the face bow into the buccal tubes which greatly reduces the risk of injury to your patients
- Patients can easily remove Nitom or lock it safely in place
- Fits most standard tubes
- Designed by British orthodontist Russell Samuels
- New and improved with laser welded construction



Size	Inner Bow Size	Short Outer Bow	Standard Outer Bow
1	83mm	TOC-501	TOC-601
2	90mm	TOC-502	TOC-602
3	97mm	TOC-503	TOC-603
4	104mm	TOC-504	TOC-604
5	111mm	TOC-505	TOC-605

Hamill Safety Facebows

The sharp distal ends of conventional facebow inner arches have caused numerous injuries, some severe. The rounded distal ends of our Hamill Safety Facebows protect against both intra and extra oral injuries. In addition, the easy spring action of the Hamill reduces the possibility of loose bands and makes insertion simple.

**DENTSPLY
GAC**



Size	Special Short	Short
1	08-419-10	08-429-10
2	08-419-20	08-429-20
3	08-419-30	08-429-30
4	08-419-40	08-429-40
5	08-419-50	08-429-50
6	08-419-60	08-429-60



TOC Impression Trays

Perfect impressions first time

- Excellent rigidity with no distortion when seating or removing tray
- Superior alginate retention for a clean complete impression
- No tray adhesive required



BEST SELLER

Size (Pk 50)	Upper	Lower
1 - Red (Pedo)	RT-100-01	RT-000-01
2 - Orange (Extra Small)	RT-100-02	RT-000-02
3 - Blue (Small)	RT-100-03	RT-000-03
4 - Green (Medium)	RT-100-04	RT-000-04
5 - Yellow (Large)	RT-100-05	RT-000-05
6 - Purple (Extra Large)	RT-100-06	RT-000-06
Mixed Bag (Pk 40 U/L Sizes 2-5)	RT-600-00	

Upper

Lower



Full range of sizes to ensure the right fit

Tra-Tens® Impression Trays



Perforated trays

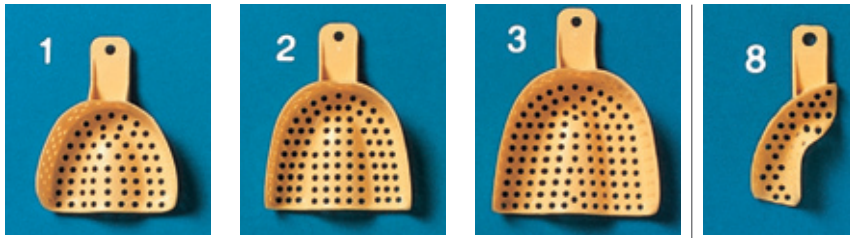

1 Small Upper 2 Medium Upper 3 Large Upper 8 Bilateral UL/LR

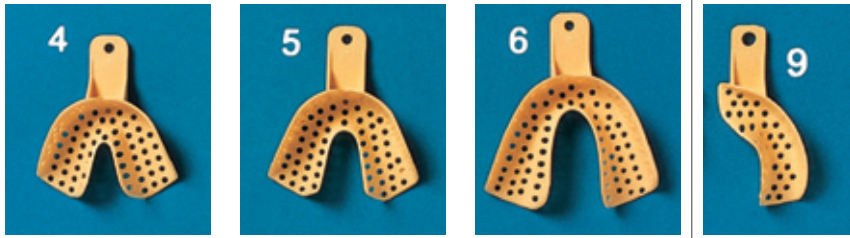

4 Small Lower 5 Medium Lower 6 Large Lower 9 Bilateral UR/LL

Tra-Tens impression trays offer excellent mechanical retention and are ideal for alginate impressions. A fully perforated tray pattern helps ensure consistent impressions. Tra-Tens impression trays are available in nine sizes.

Size (Pk 12)	Code
1 Small Upper	TOC013451
2 Medium Upper	TOC013452
3 Large Upper	TOC013453
4 Small Lower	TOC013454
5 Medium Lower	TOC013455
6 Large Lower	TOC013456
8 Bilateral UL/LR	TOC013458
9 Bilateral UR/LL	TOC013459

Replicate™

Chromatic alginate for high precision impressions

- Designed for orthodontics and high precision dentistry
- High accuracy to 20 microns for finer detail
- Colour changing - purple for mixing, pink to load the impression tray and yellow for insertion into the mouth
- Extra fast setting time in the mouth - with a minimum of only 30 seconds
- High elasticity and resistance to tear
- High dimensional stability - over 100 hrs
- Easy to mix and dust free



- easy to mix
- only 30 seconds in the mouth
- dust free
- stable for 100 hours
- accurate to 20 microns

Only 30 seconds in the mouth

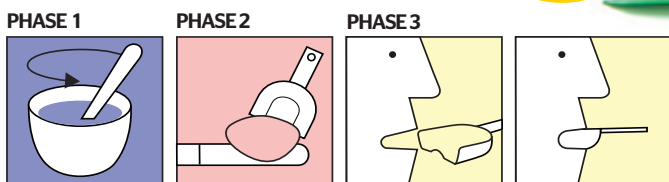

*Mixing time = 45 secs
 *Total working time = 1 min 45 secs
 *Setting time = 3 mins

Product	Code
Bag - 450g	RR-450-00
Starter Kit (2x450g, measures, container)	RR-450-10
Measure Set	RR-100-00
Storage Container	RR-200-00



Ideal®

Fast Set Orthodontic Alginate

A heavy body, fast set alginate that is specifically designed for orthodontics and user friendly. Over 25 years of consistent results prove its reliability.



Product	Code
454g Can	55-004-40
Case of 12 Cans	KIT55-004-40

DENSPLY GAC



Mixing Time:
45 seconds



Total Working Time:
1 minute 15 seconds



Initial Set Time:
1 minute 30 seconds

Total Set Time:
3 minutes

Orthoprint

Fast Set Orthodontic Alginate



- Extra-rapid working and setting times
- Thixotropic, non-drip and highly elastic
- Vanilla flavour - works with alginate flavours too
- 5 year shelf life
- Gluten free
- Easy to mix and dust free



Mixing Time:
30 seconds



Total Working Time:
1 minute 5 seconds



Intro kit includes:

2 x 500g bags, measure & container

Product	Code
500gm Bag	302145
Measuring Set	105182
Intro Kit	302161



Initial Set Time:
45 seconds

Total Set Time:
1 minute 50 seconds

Alginate Flavouring

Makes taking an impression more pleasant for the patient. Many great flavours to choose from.

Alginate Flavourings

2 fl oz (56.7gm) per bottle

Product	Code
Strawberry	RF-250-01
Peppermint	RF-250-02
Cherry	RF-250-03
Bubble Gum	RF-250-04
Pina Colada	RF-250-05
Cola	RF-250-06
Banana	RF-250-07
Chocolate	RF-250-08
Cotton Candy	RF-250-09
Cookie Dough	RF-250-10
Grape	RF-250-11
Rootbeer	RF-250-12
Raspberry	RF-250-13
Orange	RF-250-14
Blueberry	RF-250-15
Fruit Punch	RF-250-16
Watermelon	RF-250-17



Cavex Alginate Mixer II

Perfectly mixed alginate at the push of a button

- Perfectly mixed, homogeneous and smooth alginate
- Standardises procedures in the dental surgery
- Better alginate paste will result in more accurate impressions
- Easy to use, easy to clean
- Hygienic modern design

Code
TOC-CAVEX



Alghamix II

Mixing Machine

Zhermack, world leader in the production of impression materials and dental equipment, is proud to present ALGHAMIX II one of the best known mechanical mixers on the market. Ergonomic design and extremely easy to use, it guarantees perfect bubble-free mixing.

Advantages

- 30% reduced mixing time when compared to manual mixing
- Reduced air incorporation during mixing
- Homogeneous bubble free mixing
- Constant bowl rotation guaranteed by the two speeds
- Structure and design specifically designed to guarantee maximum stability during use
- Ergonomic bowl position which allows for optimal operating conditions
- Easy to remove and easy to clean bowl
- 600cc bowl for plaster and silicone mixing plate usable for various purposes

Features

- 2 speed rotation
- Ergonomic speed selector
- Bayonet bowl-fastener
- Available bowls: small 350 cc for alginate, large 600 cc for plaster
- Plate with 20-sheet mixing block for silicones
- ABS body



Enlargement of a manual alginate mix



Enlargement of an automatic alginate mix with ALGHAMIX II

Contains:

Alginate mixer, mixing bowl, spatula and instructions

Product	Code
Alghamix II	TOC303215
Bowl 350cc Light Blue	TOCC303155

Alginator



The easiest way to mix alginate and stone without the hassle! The new and improved mixer makes a smooth, bubble-free mix while eliminating waste and reducing clean up time. The sleek new design has been updated to compliment your surgery. Ergonomically designed, with a single speed and improved portability.



Product	Code
Alginator II Kit	DS-25231
Replacement Bowl	25235
Replacement Spatula	25234
Clean & Lube Spray, 4oz	23070

Alginate Mixing Bowls

- Made from extremely smooth and pliable plastic, for easy mixing and cleaning
- PVC is not used in the manufacturing process, eliminating any danger of migrating plasticisers
- Glossy inside surface, making alginate removal easy



Product	Code
Tropical Blue	97-930-10
Tropical Orange	97-930-11
Tropical Pink	97-930-12
Tropical Green	97-930-13

Plastic Alginate Spatulas

- Designed to fit all mixing bowls
- Will not scratch the surface of bowls and cleans up easily
- Perfect combination of flexibility and stiffness for good control
- Easy grip handle reduces slipping



Product	Code
Tropical Blue	97-930-20
Tropical Orange	97-930-21
Tropical Pink	97-930-22
Tropical Green	97-930-23



EXAFAST™ NDS

Fast set impression material

EXAFAST NDS is a fast setting PVS impression material designed for use with a cartridge dispenser gun. EXAFAST offers simplicity, accuracy and increased productivity. This delivery system makes extrusion of the material easy.

- **Fast Setting PVS Impression Material**
- **Perfect Impression Material for Clear Aligners**



- **Fast Setting:** EXAFAST has a total setting time of 2 minutes and 30 seconds
- **Consistently Accurate:** Highly precise and crisp impressions
- **Unsurpassed Dimensional Stability:** Won't shrink or become distorted
- **Replicates True Detail:** Penetrates critical hard to reach areas
- **Excellent Elastic Recovery:** Impressions and models are removed easily without tearing or deformation
- **Multiple Pour Capability:** Consistently accurate models from a single impression
- **No odour, No taste:** Preferred by patients
- **Bright colours:** Details read easily



Product	Code
Cartridge Dispenser Type II NDS	TOC152101



Exafast™ NDS

Monophase

- Single phase technique with one viscosity
- Easy to syringe with enough compression to attain accurate impressions

Monophase Material

Kit includes: 2 x 48ml cartridges (96ml total) 6 mixing tips and instructions

Product	Code
Monophase Material	TOC137407
Mixing Tips II Large - Purple (Pk 48)	TOC800101

Exafast™ NDS

Injection Type Wash

- Syringeable wash material for double phase impressions
- Thinner wash that is less thixotropic and more flowable
- Stays in place as pressure is applied to capture critical detail

Injection Type Material

Kit includes: 2 x 48ml cartridges (96ml total) 6 mixing tips and instructions

Product	Code
Injection Type Material	TOC137107
Mixing Tips II Small - Pink (Pk 48)	TOC800100
Intraoral Tips (Pk 100)	TOC800119

Exafast™ NDS

Regular Type Wash

- Slightly thicker wash material used with double phase impressions
- Syringeable wash that is a little more thixotropic and less runny than injection material
- Stays in place until pressure is applied to capture critical detail

Regular Wash Material

Kit includes: 2 x 48ml cartridges (96ml total) 6 mixing tips and instructions

Product	Code
Regular Wash Material	TOC137007
Mixing Tips II Large - Aqua (Pk 48)	TOC900114
Intraoral Tips (Pk 100)	TOC800119

EXAFAST™ Putty



EXAFAST Putty is a vinyl polysiloxane material, consisting of a base and a catalyst that are easy to manipulate for accurate, void-free impressions.

EXAFAST Putty produces crisp, extraordinarily smooth and precise impressions and can be used with either regular or injection wash material.

- The highest compression tray material used with double phase impressions
- Extremely smooth and easy to hand mix (avoid contact with latex, oils and moisture when mixing).
- 45 seconds working time
- Sets after only 2 ¼ minutes in the mouth



Easy To Mix and Use

1:1 Base and catalyst ratio

Hand mix and place in impression tray

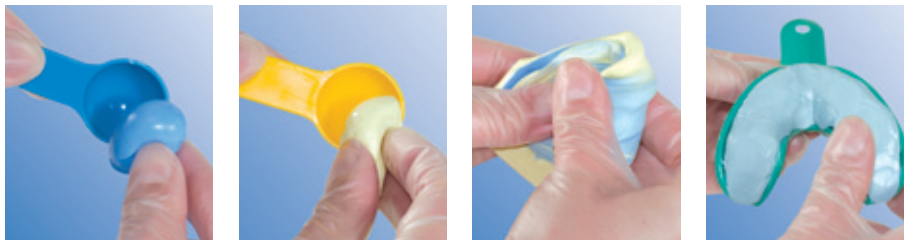

Kit includes:

1 x jar putty base (500g), 1x jar putty catalyst (500g), scoops and instructions

Product	Code
Putty Standard Pack	TOC137307

Exabite™ II NDS Registration



Fast Formulation PVS Bite Registration Material with Outstanding Accuracy

- Bite registration material is easy to apply and will not slump or run
- Ideal cream-like consistency allows patients to occlude without deviation or distortion
- Sets quickly in only 45 seconds and is easy to trim if necessary



Kit includes: 2 x 48ml cartridges (96ml total) 12 mixing tips and instructions

Product	Code
Bite Registration Material	TOC890014
Mixing Tips II L - Aqua (Pk 48)	TOC900114

Wonderfill™

Tongue Filler



1. Remove a palm full of non-toxic Wonderfill and form a domed bridge in the tongue area.
2. With Wonderfill in the tongue area, pour plaster/stone.
3. Let plaster/stone fully set. Then pop out non-sticky Wonderfill for a clean model, using only water & brush to remove any residue.

SAVES TIME!

Produces a sleeker, more presentation-worthy model!
No mixing. No mess.
No wasted time!

**when compared to stone or plaster mixes*



ALTERNATIVES

Plaster/Stone residue when no tongue filler used.

- Tedious, time consuming grinding out the build up
- Messy
- Coarse model appearance

Alginate as the tongue filler

- Mixing
- Messy and hard to form
- Set-up and clean-up time required
- Often needs carve-out of residue



Product	Code
Wonderfill 3.5lb tub	30200

Alcohol Marking Pens

These alcohol-based pens are specially made for the moist oral / lab environment. Colour-coded and will mark all types of acrylic, wire, plaster and stone models. Pens feature an extra fine tip.



Colour	Code
Red	1390626
Green	1390627
Black	1390628
Blue	1390629

Exacto Bites

- Occlusal registration
- Can be used with either wax or silicone registration materials

Colour (pk 25)	Code
Blue, 2mm	TOC-EXACTO-2
White, 4mm	TOC-EXACTO-4



Indelible Pencils

Ideal for marking designs on alginates and for permanently identifying plaster models.



Colour	Code
Red	TOC-INDEL
Blue	TOC-INDEL-B

Ortho Model™ Archival System

Ortho Model Archival System offers surgeries an innovative and simple solution for archiving patient models, freeing up valuable practice space.

4 BOXES PER SET

Each set includes:

4 boxes with 4 trays each, for a total of 16 trays. Each tray has 20 model compartments, for a total of 320 model compartments per set.



Store and Organise Patient Study Models

- Saves valuable office space
- Inexpensive storage
- Holds 320 models
- Easy to assemble
- Super strong construction

Product (Pk 4)	Code
Front Loading	37809
Top Loading	37810



**1 PACK
INCLUDES
4 BOXES OF
STORAGE!**

FRONT LOADING STYLE

USE FOR ACTIVE CASES
1 set of 4 large boxes (16 trays)
16" H x 18 3/4" W x 13" D

TOP LOADING STYLE

USE FOR FINISHED CASES
1 set of 4 large boxes (16 trays)
15" H x 19 1/2" W x 13 1/4" D

Study Model Boxes

These popular study model boxes are available in 3 useful sizes.



Product	Code
8" x 3" x 3"	TOC-STUDY1
9" x 3" x 3"	TOC-STUDY2
11" x 3" x 3"	TOC-STUDY3

Model Boxes

Durable plastic will not deform when sending in the post. Interior foam material provides protection and moisture retention which can be adjusted to fit.



Product (Pk 52)	Code
Model Shipping Case	TOCMSB-52
Impression Tray Shipping Case	TOCMSBIT-52

Plastic Model Base Former

Polybases are a great way of producing excellent models without all the extra work of model trimming. Achieve perfect model angulation every time.

- Simple to use
- No trimming – no dust
- Plastic – white colour



Product	Code
100 Upper & 100 Lower, with hinges	TOC-PB
100 Hinges	TOC-PBH

Model Base Former

Pour up beautiful angled models without trimming

- Universal for upper and lower forms
- Flexible and durable
- Large size allows sufficient plaster for base
- Reusable



Inner Dimensions:
4¼"W x 2 7/8"L
x 1"D (at front)

Code
RM-100-01

Soft Bite Wax

Bite registration wax.

- Soft and pliable.
- Sheet size: 120mm x 75mm x 2.4mm



Product (Pk 24)	Code
Ortho Bite Wax	TOC-SRBW

Crystacal R Plaster

Crystacal R is a unique white fine grade plaster produced from high purity minerals. Plus its extra hardness makes Crystacal R ideal for orthodontic study models.



Setting time is 10 – 15 minutes.

Product	Code
12.5kg	TOC-PLASTER1
25kg	TOC-PLASTER

Model Glow

Gives an incredibly high lustre to gypsum models. Its special formulation does not yellow or flake and seals the pores to provide a protective coating. Its thin consistency does not affect occlusal accuracy. Long lasting and can be used full strength or diluted. Models can be buffed wet or dry.



Product	Code
Model Glow - 1 gallon	29009

Anutex Modelling Wax



Sheet size: 187mm x 88mm x 1.5mm



Anutex translucent pink modelling wax sheets.

- Will not irritate oral tissues
- No unpleasant odour or flavour
- Softens without becoming flaky or crumbly
- Does not adhere to fingers
- Trims easily and cleanly
- Shows a smooth glossy surface after gentle flaming
- Does not distort in the mouth

Product	Code
500gm (24 sheets)	TOC-WAX017
2.5kg (120 sheets approx)	TOC-WAX217

Plaster Mixing Bowl

Rubber mixing bowl designed for hand mixing gypsum products.



Product	Code
Small 105mm x 70mm	TOC-MBS
Medium 125mm x 90mm	TOC-MBM
Large 130mm x 110mm	TOC-MBL
X Large 150mm x 150mm	TOC-MBXL

Laminated Bite Wafers



Aluminium foil is laminated between two layers of soft bite wax. The foil lessens distortion and prevents the patient from biting through the wafer.

Product (Pk 24)	Code
Bite Wafers	RU-025-00

Impression Separation Wafers

Impression separation wafers create space in a first impression to be used later as a custom tray.



Product (Pk 30)	Code
Bite Wafers	TOC800099

White Utility Wax Strips

- Soft and pliable
- Great for building up impression trays



Product (Pk 80)	Code
Wax Strips 3/16" x 11"	RU-020-00



Pure Plastics™

Quick - Easy - Affordable



Crystal™

Clear Retainer Material

Offers excellent clarity and is the preferred option when acrylic needs to be incorporated into the appliance.

- Almost invisible in the mouth
- Excellent rigidity - ideal for tooth movement
- Accepts bonding agents
- May also be used for retainers
- Perfect for creating bite planes and TMJ splints

Product (Pk50)	Code
0.5mm / .020" Square	C-20-127S
0.75mm / .030" Circle - 120mm	C-30-120C
0.75mm / .030" Square	C-30-127S
1mm / .040" Circle - 120mm	C-40-120C
1mm / .040" Circle - 125mm	C-40-125C
1mm / .040" Square	C-40-127S
1.5mm / .060" Square	C-60-127S
1.5mm / .060" Circle	C-60-125C

Opal™

Durable Retainer Material

Provides durability and strength making it the first choice for retainers.

- Natural looking
- Tough - ideal for retainers
- May also be used for tooth moving appliances
- Abrasion resistant - ideal for patients who brux

Product (Pk100)	Code
1mm / .040" Circle - 120mm	O-40-120C
1mm / .040" Circle - 125mm	O-40-125C
1mm / .040" Square	O-40-127S

Diamond™

Whitening Tray Material

Specially made for whitening trays.

- Easy to work with
- Exceptional performance

Product (Pk25)	Code
1mm / .040" Circle	D-40-125R
1mm / .040" Square	D-40-127S
1.5mm / .060" Circle	D-60-120R
1.5mm / .060" Circle	D-60-125R
1.5mm / .060" Square	D-60-133S
2mm / .080" Square	D-80-133S

Ice™

Retainer Material

Offers a great combination of strength and clarity for a superior invisible appliance.

- Forms clear for great aesthetics
- Perfect for invisible retainers, minor tooth movement and temporary bridges
- Superb thermoforming properties

Product (Pk20)	Code
0.75mm / .030" Square	I-30-127S
0.75mm / .030" Circle	I-30-125C
1mm / .040" Circle	I-40-120C
1mm / .040" Circle	I-40-125C
1mm / .040" Square	I-40-127S
1.5mm / .060" Square	I-60-127S

All trademarks are the property of their respective owners

Gem™ Dual Laminates

Strength with comfort

Features a hard outer surface for strength and durability. This outer layer can withstand the strong forces of the bite and night time grinding (Bruxism). The inner soft surface gives comfort and adaptability - just the benefits the patient wants. Combines all the properties you need in a blank.



Product (Pk 5)	Code
2 mm	DL-20
3 mm	DL-30
4 mm	DL-40

Gem™ Mouthguard Material

Clear

EVA is a great material for making both mouthguards and night guards because of its high energy absorbing properties. Gem Mouthguard blanks are made of pure EVA so you can be sure you're using quality materials. Available in 125mm x 125mm square, we also supply circle blanks please substitute "C" instead of "S" in the code.

Size	Code
1 mm / .040"	G-40S-CLEAR
1.5 mm / .060"	G-60S-CLEAR
2 mm / .080"	G-80S-CLEAR
3 mm / .120"	G-120S-CLEAR
4 mm / .160"	G-160S-CLEAR
5 mm / .200"	G-200S-CLEAR
6 mm / .240"	G-240S-CLEAR

Sizes 2mm, 3mm & 4mm are also available in packs of 20. Add 20 to the end of the code.

Silicone Lubricating Spray

High quality silicone lubricant. Helps eradicate the plastic and frame sticking problems which can happen when vacuum forming. Just spray the frame and model to stop sticking. 400ml spray can.



Product	Code
400ml spray can	TOC-LUBSPRAY

Gem™ Mouthguard Material

Coloured

Specially formed EVA which heats and forms easily with superior fit to the model. 125mm x 125mm.

- Material forms soft and flexible
- Great choice of colours
- Good durability



When ordering, please replace the asterix with the colour code. For circle blanks, please substitute "C" instead of the "S", for square, in the code.

Available Colours

Amethyst (AME)	Fluorescent Pink (FPI)	Mint Green (MIN)
Apple Green (APP)	Fluorescent Red (FRE)	Pink (PIN)
Aussie Yellow (AUS)	Fluorescent Yellow (FYE)	Racing Green (RAC)
Black (BLA)	Gold (GOL)	Red (RED)
Brown (BRO)	Green (GRE)	Royal Blue (ROY)
Cerise (CER)	Lavender (LAV)	Sandstone (SAN)
Cherry Red (CHE)	Leaf Green (LEA)	Shrimp Pink (SHR)
Cornflower (COR)	Lilac (LIL)	Silver (SIL)
Dark Blue (DAR)	Maroon (MAR)	Sky Blue (SKY)
Fluorescent Green (FGR)	Metallic Green (MET)	Teal (TEA)
Fluorescent Orange (FOR)		Turquoise (TUR)
		White (WHI)
		Yellow (YEL)

Product (Pk 5)	Code
1 mm / .040"	G-40S-*
2 mm / .080"	G-80S-*
3 mm / .120"	G-120S-*
4 mm / .160"	G-160S-*
5 mm / .200"	G-200S-*

Triad Gel

Blocks out undercuts on models. Can also be used for correcting discrepancies on models. Creates bite planes and splints.

Product (22gm)	Code
Pink	25-300-05
Clear	25-300-09



Chilling Spray

- Instantly cools Pure Plastics
- Produces a better fit for all appliances
- Cools down to -50°C
- 200ml spray can

Product	Code
200ml spray can	TOC-COLDSPRAY



Easy Vac

Vacuum Forming Machine

Quick and easy to use, this stylish "suck-down" machine has its own built in vacuum so no compressor is needed. The Easy Vac has a stable base, safe and convenient controls and comes fully assembled. Compact in size this unit takes up a minimum amount of space. Uses square material. Weight 6.9 kg.

- Invisible Orthodontic Retainers
- Tooth Movement Techniques
- Bite Raisers
- Indirect Bonding Trays
- Tooth Whitening Trays
- Sports Mouthguards
- Bruxism Splints
- Sleep apnoea appliances



Code

TOCEV2

Tri Cutter

Super coarse for cutting thermoplastic, acrylic and tray materials. 10,000 rpm



These micro-structured carbide cutters are manufactured with today's most advanced technology.

- Longer life even in the case of extended use
- Precise instrument balance (less than 0.015mm) allows smoother running of handpiece, reduces vibration and extends life of chuck and bearings
- Optimal cutting of material
- Improved cutting efficiency due to innovative cutting geometrics
- Shank is accurately soldered to improve balance and safety

Code (Pk 3)

TOC80049

Cutting Wheel

Quickly cuts away plastic from model

- High quality steel
- One piece tool
- Max rpm 10,000
- Diameter 10mm



Code

UW-888-00

Electric Heated Knife

A quick and easy way to cut around the appliance without damaging the model, allowing multiple appliances to be made much quicker.



Code

IS-88500-240

Pure Light Cure Blue Block Out Material

- Blue colour makes for easy application to model
- Block out undercuts
- Make reservoirs for bleaching trays
- Repair holes or small fractures on models
- Great for use on plaster models
- Predictable light curing



Product

4 x 1.2gm syringes + 20 tips

Code

30-201

Blockout Compound

This material is designed to be resistant to heat and force so is great for blocking out undercuts on a model or creating space.

It's reusable, easy to position and won't droop or stick to models. 60gm block.



- Heat resistant
- Force resistant
- Reusable & easy to position

Code

25-183-00

Curved Mayo Scissors

For shaping a Pure Plastics retainer or appliance on the labial area.

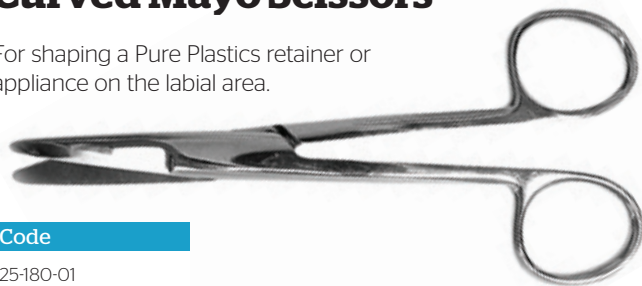

Code

25-180-01

Small Curved Scissors

For precise shaping of a Pure Plastics retainer or appliance especially the lingual aspect.



Code

US-180-02

Serrated Trimming Scissors

Serrated design for controlled trimming without slippage. Curved tip cuts easily and precisely, even in hard to reach lingual areas.

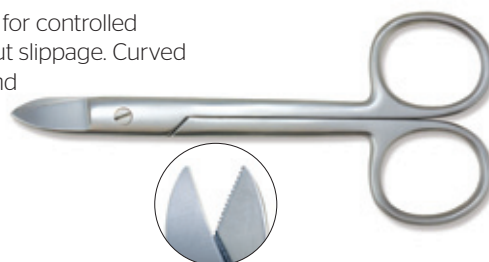

Code

US-180-03

Large Shears

All purpose utility shears. The easy grip handles makes cutting the stiffer and thicker areas of blanks and mouthguards much easier.



Code

TOC-E0650

Silicone Polishers - Latex Free

These Silicone Polishers are available in three different grits for polishing prosthetic and orthodontic acrylics. Featuring low wear, these polishers are extremely long lasting. Pick the best shape for you. Max 15,000 rpm.

STEP 1 Green: *Removing and Shaping*

STEP 2 Grey: *Smoothing*

STEP 3 Yellow: *High Shine Polishing*



Size (Each)	Code
Green - Large Taper	TOC-SP12
Green - Bullet	TOC-SP13
Grey - Large Taper	TOC-SP22
Grey - Bullet	TOC-SP23
Grey - Bell	TOC-SP24
Yellow - Large Taper	TOC-SP31
Yellow - Bullet	TOC-SP32
Yellow - Bell	TOC-SP33

Scotchbrite Wheels

Scotchbrite wheels are available in 4 different grades and are ideal for working with a variety of different materials. The soft and flexible, non-woven material used in the construction of the discs provides a much longer life due to low thermal build-up and the open structure of fibres which is ideally suited to smooth plastics, silicones and other soft materials. Can also be used for the polishing of mouth guards, dental splints etc. Max rpm. 10,000

- Gentle pre-polishing without polishing paste
- Reaches concave surfaces with ease
- Consistently good results throughout the entire service life



Size (pk 10)	Colour	Material	Code
25mm Diameter	White	Non-abrasive	TOC-SBW
25mm Diameter	Grey	Coarse	TOC-SBC
25mm Diameter	Brown	Medium	TOC-SBM
25mm Diameter	Red	Fine	TOC-SBF

Super Silicone Polishers

Super acrylic polishers for a quicker and finer result, producing less dust.

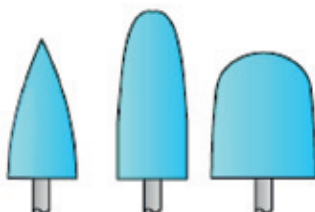

Shape (pk10)	Length	Diameter	Code
Large Taper	20mm	10mm	TOC-SP171
Bullet	24mm	10mm	TOC-SP172
Bell	18mm	15mm	TOC-SP173

Intensiv Ortho-Strip System



Safe and precise

The Intensiv Ortho-Strip System combines a Kavo handpiece with Intensiv Ortho-Strips to provide the safest and most precise option available for interproximal reduction offering outstanding reliability. The Intensiv Ortho-Strip kit is an irrigated system reducing friction and heat thereby improving patient comfort. The comprehensive kit includes a Kavo contra angle handpiece with head, double sided Ortho-Strips, measuring gauge and cleaning block.

- Rapid and controlled reduction of enamel
- Safe and precise
- Outstanding reliability
- Fully autoclavable strips

The reduction area may be approached from multiple angles as the handpiece head rotates 360 degrees and contouring is achieved using the flexible diamond strips.

Intensiv Ortho-Strip Kit

Kavo Contra Angle Handpiece Head, Set of 4 Double Sided Ortho-Strips, Set of Measuring Gauges and Diakleen Cleaning Block.



Code

KIT97-990-00

It is important to proceed systematically following a coarse to fine sequence in selecting grits. Unlike manual strips, the Ortho-Strip system provides rapid, controlled enamel reduction followed by polishing without unnecessary removal of healthy tooth substance.

Double Sided Ortho-Strips

- Flexible strips, diamond coated on both sides
- Proximal contouring, finishing and polishing of both adjacent teeth in a single procedure
- No injuries to patient (lips) or dentist (fingers)
- Available singly or in a set
- Fully autoclavable strips



Single Sided Ortho-Strips

- Flexible strips, diamond coated on one side
- For extra safety, these help preserve healthy tooth substance in the adjacent teeth
- No injuries to patient (lips) or dentist (fingers)
- Left and right versions for mesial and distal in the upper and lower jaw
- 4 different grades



Strips	Left	Right
15µm Yellow	97-990-25	97-990-29
25µm White	97-990-24	97-990-28
40µm Red	97-990-23	97-990-27
60µm Brown	97-990-22	97-990-26



Product	Code
Single Sided Set (L & R of each - OS15/OS25/OS40)	97-990-21

Strips (Sold Individually)	Code
15µm Yellow - Pre-Polishing	97-990-19
25µm White - Finishing	97-990-18
40µm Red - Contouring	97-990-17
60µm Brown - Reduction	97-990-06
90µm Clear - Separating	97-990-16
Double Sided Set A (OS90/OS40/OS25/OS15)	97-990-12
Double Sided Set B (OS60/OS40/OS25/OS15)	97-990-11

Diakleen

Rubber Block for rapid cleaning of clogged Intensiv Ortho-Strips and other diamond instruments.



Code

TOCACC-6000

Spacefile® Interproximal Reduction Kit

Versatility and Value

The SpaceFile Interproximal Reduction System is a complete system that includes the handpiece, the SpaceFile IPR files and accessories. The precision Swiss-made diamond-impregnated files can accomplish a wide range of tasks including interproximal reduction, contouring, polishing and finishing.

- Swiss-made, diamond-impregnated files
- Uses include breaking contact, reduction, contouring, fine trimming and finishing
- Designed to allow low temperature operation and prevent clogging
- Double-sided and single-sided
- Files, grip and inner tray are autoclavable
- Colour coded for easy identification
- Competitively priced



Spacefiles SWISS MADE



POLISHING

A final step in tooth surface restoration.



FINISHING

For finishing prior to final polish.



XX FINE

Pre-polish and finish reduced areas. Also use as initial strip for excessive crowding.



X FINE

Pre-polish stripped areas. Also use as initial strip for crowded cases.



FINE

Use to initiate reduction in crowded cases. Also use to contour after reduction.



MEDIUM

Use for reduction with some crowding or when some space exists.



COARSE

Primary working strip for IPR. Also use to trim and contour.



X COARSE

Use for maximum reduction at start of IPR.



SERRATED CONTACT POINT SAW

Use to break contact points on enamel, composite, amalgam, porcelain or gold.



REMOVABLE GRIP

Strips may also be used hand held with this removable grip.

Spacefile® Interproximal Reduction Kit Includes:

W&H Handpiece, Assorted pack of Spacefiles and Measuring Gauge.

Code

KIT04-500-10

Product

Compact ITS™
Contra-Angel Handpiece

Code









04-500-01

Product (Pk 3)

Spacefile Removable Grip

Code

04-500-04

Single Type Packs (Pk 8)	Double-Sided	Single-Sided (Left)	Single-Sided (Right)
 Polishing (DS .085mm, SS .070mm)	04-500-60	04-500-60L	04-500-60R
 Finishing (DS .110mm, SS .110mm)	04-500-30	04-500-30L	04-500-30R
 XX Fine (DS .140mm, SS .140mm)	04-500-15	04-500-15L	04-500-15R
 X Fine (DS .160mm, SS .138mm)	04-500-25	04-500-25L	04-500-25R
 Fine (DS .270mm, SS .180mm)	04-500-40	04-500-40L	04-500-40R
 Medium (DS .330mm, SS .210mm)	04-500-150	04-500-150L	04-500-150R
 Coarse (DS .370mm, SS .235mm)	04-500-90	04-500-90L	04-500-90R
 X Coarse (DS .490mm, SS .290mm)	04-500-120	04-500-120L	04-500-120R
 Serrated Contact Point Saw	04-500-22	-	-
Assorted Packs	04-500-10	04-500-10L	04-500-10R

Single Type Packs include: Removable Grip and 8 files Assorted Pack includes: Removable Grip, 8 files (One of each thickness) and 1 Serrated Contact Point Saw

HandyStripper Kit

Compact Interproximal Stripping System

Specially designed for breaking contact points in tight interproximal spaces, the small HandyStripper delivers control and stability at your finger tips. Made of high grade autoclavable stainless steel with easy-to-replace diamond strips. Compact size so safer to use and variety of sizes makes it ideal for every interproximal stripping need.

Kit Includes: HandyStripper handle, 5 x Micro Saw 4mm, 10 x Single Sided 4mm Strips, 10 x Double Sided 4mm Strips

Product	Code
Handy Stripper Kit	IS-300-01
4mm Medium Single Sided Strip (Pk 10)	IS-300-02
4mm Medium Double Sided Strip (Pk 10)	IS-300-03
4mm Micro Saw Strips (Pk 10)	IS-300-04

Compact and lightweight

- Easy to control even in tight spaces
- Safe and controllable
- Durable made of stainless steel
- Autoclavable



Intensiv ProxoStrip

Practical, fast, ergonomic

A unique, diamond-coated metal strip for final polishing of proximal surfaces. A metal strip with grip secure strip ends, diamond-coated on one side, with two working areas of different grit sizes.

- Sterilisable, reusable
- Finishing and polishing in one process
- Ergonomic grip for simple, safe use
- Short strip for improved finger support while stripping

Product	Code
Pack 6	TOC-PX4015-6
Pack 12	TOC-PX4015-12



Intensiv ApproXOpener

A double sided manual metal strip with saw and diamond coated options for efficient and fast opening of narrow interdental spaces. Designed with safe handles and low risk of damage to soft tissue.

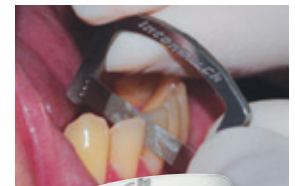

Product (Pk 3)	Code
Saw	TOC2018
One Sided	TOC2018OS
Double Sided	TOC2018DS

Incremental Thickness Gauges

Pack of six gauges for measuring interproximal spaces. Dimensions are 0.1mm, 0.2mm, 0.25mm, 0.3mm, 0.4mm, 0.5mm.



Code
IG-105-06



Intensiv IPR Distance Control

A complete and practical instrument with a safe grip for the measuring and control of interdental distances during interproximal reduction. Includes 8 sizes: 0.1mm, 0.15mm, 0.2mm, 0.25mm, 0.3mm, 0.4mm, 0.5mm and 1mm.



Code
TOCIPR-DC

Intensiv ProxoShape Set

Diamond coated files for the contouring and finishing of proximal restoration surfaces. Use with reciprocating handpiece.



Code
97-990-13

QUANTUM™

BURS, DISCS & STRIPS

Interproximal Diamond Strips

Perforated and flexible

- Perfect for interproximal reduction recontouring and finishing contact points
- Single sided
- Autoclavable
- 2 widths: Narrow (2.5mm) and Wide (3.75mm)
- 4 grades: coarse, medium (45 micron), fine (30 micron), extra-fine (15 micron)

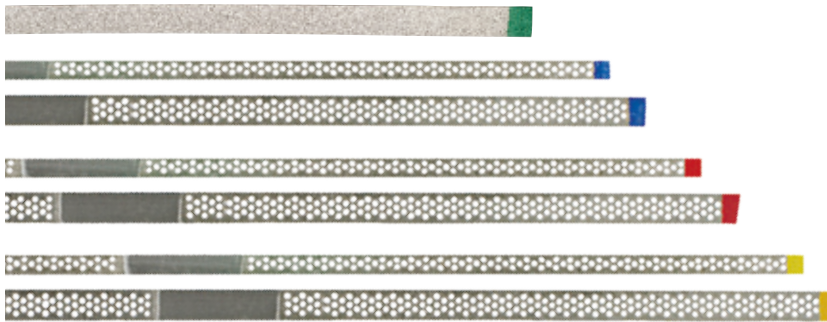

Interproximal Strip (Pk 10)	Narrow	Wide
Extra Fine (Yellow)	IS-600-03	IS-500-03
Fine (Red)	IS-600-02	IS-500-02
Medium (Blue)	IS-600-01	IS-500-01
Coarse (Green)	-	IS-700-00

Interproximal Strip Kit (Pk 15)	Code
Narrow kit (includes 5x Extra Fine, 5x Fine, 5x Medium)	IS-600-00
Wide kit (includes 5x Extra Fine, 5x Fine, 5x Medium)	IS-500-00

Interproximal Diamond Burs

It is recommended to begin with the medium diamond to quickly remove the required amount of enamel. Follow up with the fine diamond to smooth the tooth surface creating a precise, parallel end result.



- Consistent grit size
- Friction grip
- Head length 10mm
- Excellent diamond particle exposure

Heat sterilisable up to 340°F/170°C
Autoclavable up to 250°F/121°C

Product (Pk 5)	Code
Fine Grit (Red)	8859-31-010
Medium Grit (Blue)	859-31-010

Interproximal Strip Tube

- Capable of sterilising 15 interproximal strips at a time
- Aluminium tube fits easily into your autoclave



Code

25-535-00

Safe-Tipped Air Rotor Stripping Bur Kit

Sterilisable bur block containing 4 safe-tipped carbide burs, 2 medium particle size safe-tipped finishing diamond burs, 2 fine particle size safe-tipped finishing diamond burs, 2 anterior fine needle diamond burs, non-safe-tipped for anterior interproximal stripping.



Code

25-512-55

Air Rotor Stripping Diamond Burs

- May be autoclaved, chemically or dry heat sterilised
- Do not immerse in cold sterilisation solution

Fine Grit



Medium Grit



Product	Code
Fine Grit	25-848-20
Medium Grit	25-848-10

Anterior Air Rotor Stripping Diamond Burs

- No need to place a separator prior to using if teeth are parallel
- May be autoclaved, chemiclaved or dry heat sterilised - Don't immerse in cold sterilisation solution
- Friction grip



Product	Code
Head size 1.6mm, Head length 5mm	25-550-00

Safe-Tipped Finishing Burs

- Diamond coated to help produce a natural finish
- Various particle sizes, all safe tipped
- May be autoclaved, chemiclaved or dry heat sterilised - Don't immerse in cold sterilisation solution



Product (Pk 3)	Code
Medium - Head 1.4mm, Length 10mm	25-540-55
Fine - Head 1.2mm, Length 8mm	25-530-55
Extra Fine - Head 1.2mm, Length 10mm	25-520-55

Tungsten Carbide Debonding Burs

Quantum™ burs are designed, manufactured and finished for optimum strength, performance and durability offering efficient debonding and adhesive removal. They are brazed at the base of the neck as opposed to the base of the head as found in many competitor products. The stainless steel shanks allows for multiple autoclave cycles without the risk of corrosion and the convenient blister packaging keeps burs safe and well protected until needed. Exceeds all ISO, FDA, BSI and CE European standards.

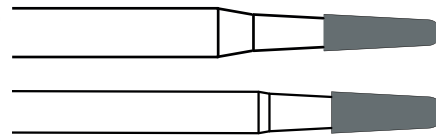

8 Flute	Right Angled (Slow)	Friction Grip (Fast)
.012" (Pk 10)	TOC1171RA	TOC1171FG
.016" (Pk 10)	TOC1172RA	TOC1172FG

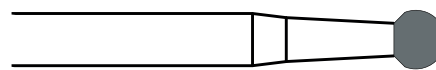

12 Flute	Right Angled (Slow)	Friction Grip (Fast)
.018" (Pk 5)	TOC7006RA	TOC7006FG

Ceramic Debonding Burs

DENTSPLY GAC burs for clearing the occlusal and gingival debonding channels of ceramic brackets.

Code (Pk 5)
110-766-40



Carbide Debonding Burs

- High precision burs for efficient finishing of composite, amalgam and enamel
- Corrosion resistant finish
- 12 Flute, friction grip
- Packs of 5

Heat sterilisable up to 340°F/170°C
Autoclavable up to 250°F/121°C



Lingual Debonding Burs

Egg shaped burs designed for lingual access adhesive removal. The smooth, safe-end non cutting tip prevents damage to the gingival surface.



Product (Pk 5)	Code
Right Angled	TOCH379-O23RA
Friction Grip	TOCH379-O23FG

Product (Pk 5)	Code
Long Taper, High speed, 8mm head	IB-310-16
Long Flame, High speed, 8mm head	IB-310-12
Football, High speed, 4.4mm head	IB-310-23

Diamond Discs

Smoothly Remove Tooth Mass

Flexible mesh design for both reduction and contouring. Smoothly remove tooth mass interproximally to create intra-arch space or open contact points between teeth. Great for use with many popular aligners including Invisalign® and Ideal Smile Aligner system. Discs are available in 19mm, for when space is limited, and 22mm.

Product (Pk 2)	Code
A. Double Sided Diamond Disc 19mm (0.17mm thick)	88617
A. Double Sided Diamond Disc 22mm (0.17mm thick)	88613
B. Double Sided See-Through Diamond Disc 22mm (0.20mm thick)	88655
C. Double Sided Mesh Diamond Disc 19mm (0.20mm thick)	88657
C. Double Sided Mesh Diamond Disc 22mm (0.20mm thick)	88656
D. Single Sided Diamond Disc 19mm (0.10mm thick)	88616
D. Single Sided Diamond Disc 22mm (0.10mm thick)	88614



- Flexible for ease of use
- Disc diameter 19mm and 22mm
- For use with low speed handpieces
- Includes 2 diamond discs and 1 mandrel

Heat sterilisable up to 340°F/170°C Autoclavable up to 250°F/121°C

Diamond Disc Intro Kit



3 Disc Kit Includes:

1 x double-sided, 1 x single-sided, 1 x double-sided see-through with mandrels and bur block

4 Disc Kit Includes:

1 x double-sided, 1 x single-sided, 1 x double-sided see-through, 1 x double-sided mesh with mandrels and bur block

Product	Code
3 Disc 19mm Intro Kit	DD-KIT2
3 Disc 22mm Intro Kit	DD-KIT
4 Disc 22mm Intro Kit	DDKIT1

Heat sterilisable up to 340°F/170°C
Autoclavable up to 250°F/121°C

Diamond Disc Metal Safety Guard

- Use with Doriot style handpiece

Product	Code
19mm	88611
22mm	88612



Autoclavable up to 275°F/135°C

Diamond Disc Plastic Safety Guard

- Disposable
- For complete visibility
- Use with Doriot style handpieces

Product (Pk 15)	Code
22mm	88615



High Shine Enamel Polisher

- 5 micron diamond grit suspended in resilient silicone used after debonding to create a high polish finish

Heat sterilisable up to 340°F/170°C
Autoclavable up to 250°F/121°C

Product (Pk 3)	Code
High speed - 8mm head	W16F
Low speed - 10.4mm head	W16D



Lip Ring Retractor

- Helps to protect lips during interproximal reduction
- Also ideal for anterior bonding and placing lingual retainers
- Cold sterilisable
- One size
- Pack of 2



Code (Pk 2)

LR-400-02



effer-ves®

Cleaning tablets for removable dental appliances

**BEST
SELLER**

A cleaning tablet specially formulated to safely freshen and clean a patient's removable dental appliance at home.

Effer-ves removes stains, harmful bacteria and bad odours; helping your patients maintain good oral hygiene as well as feel fresh and confident.



- Suitable for Clear Retainers, Wire Retainers, Clear Aligners, Mouthguards, TMJ Appliances, Bruxing Appliances and Nightguards
- Easy to use
- Safe to use on acrylic and wire combinations within orthodontic appliances

**Independently tested
by Invisalign**

Product	Code
Patient Box (32 tablets/box)	TOC-ACT
Poster	TOC-ACTP
Leaflet Holder	TOC-ACTLH
Patient Leaflets	TOC-ACTPL



YOUR SMALLEST PIECE OF EQUIPMENT,
YOUR BIGGEST **PEACE OF MIND**



BRAIN CONCUSSION
Shock Doctor's patented multi-layer construction featuring integrated jaw pads absorb shock to help protect against brain concussions.

ORAL LACERATIONS
Gel-fit™ liners surrounded by exoskeletal shock frame ensure retention and comfort while protecting against oral lacerations.

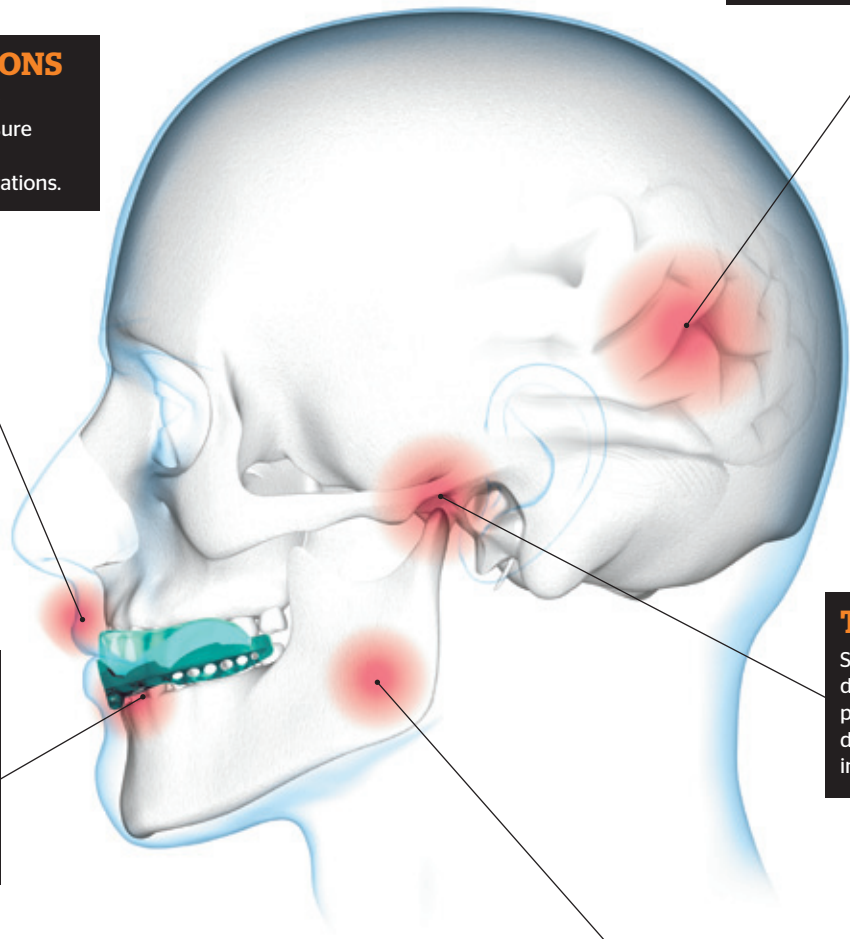

TOOTH INJURIES
Patented multi-layer, semi-rigid shock transfer core and monocoque frame construction absorb and deflect damaging impacts.

TMJ DISORDER
Shock Doctor's patented design features help protect the TM joint from dislocation and related injuries.

JAW FRACTURE
Integrated jaw pads and monocoque frame vertical wall extensions help prevent injuries caused by side and bottom jaw impacts.

Why Shock Doctor? We give technology more bite

Since being awarded their first mouthguard patent in 1992, Shock Doctor has never stopped innovating the science of mouthguard technology. Today, Shock Doctor mouthguards feature state of the art multi-layer technology and advanced custom gel fitting, all in lighter weight and lower profile designs.

When Shock Doctor introduces new mouthguard innovations, they are building upon years of experience and expertise.



Official Mouthguard Supplier to Saracens RFC





Shock Doctor Joins Forces with The American Association of Orthodontists

The AAO now supports and recognises the benefits Shock Doctor Mouthguards can give to orthodontic patients:

"Mouthguards are critical for all athletes but they're especially important when you're being treated by an orthodontist, because a blow can damage any fixed or removable device as well as the teeth, mouth and face," said DeWayne B. McCamish, DDS, MS, President of the AAO. "As orthodontists we see patients who suffer injuries that could have been prevented by mouthguards. Preventing trauma is a commitment both Shock Doctor and the AAO share."

As part of the multi-year agreement, Shock Doctor will use the AAO logo on designated retail packaging and point of sale displays and have adopted the following slogan.

"Your Smile is Your Best Fashion Accessory™"

Mouthguards for Brace Wearers

BRACES SINGLE

The single brace is specially designed for athletes with braces; it fits easily over the upper arch, protecting the fixed appliance and preventing tears and lacerations to the gums. The appliance should last throughout the treatment time as it is made from a high grade quality silicone.

Insta-Fit™

A special Ortho-Channel fits around the appliance and adapts to changes in tooth position as braces are adjusted, providing an instant fit and protection. No need to boil and no complicated fitting instructions simply **POP IT IN AND PLAY.**

100% Medical-Grade Silicone

The soft material allows the mouthguard to be manipulated around the braces giving ultimate comfort.

Air Cushioned Shock Pads

Aerofil shaped rear pads help protect the jaw, TM joints and brain, lessening the chance of concussion.

Medical Grade Silicone

Constructed of medical grade silicone for maximum comfort and compatibility with braces

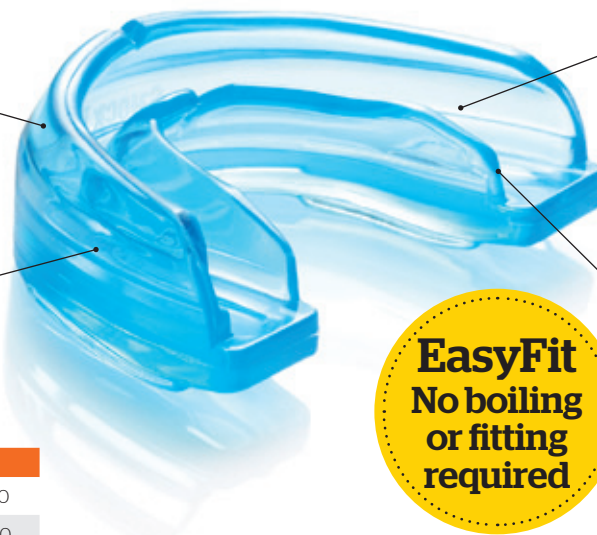

Product	Code
Single Upper - Blue	TOC-EZ4100
Single Upper - Pink	TOC-EZ4200

According to the British Orthodontic Society it is important for anyone with a brace to wear a mouthguard

For many adolescent patients, orthodontic treatment coincides with the period of greatest risk. Patients should be routinely questioned about their involvement in sport and asked if they use a protective mouthguard.

Broken appliances and missing brackets are a nuisance for the orthodontic practice and patient. Repairs can be costly in materials and time, plus emergency appointments can put you out of schedule for the whole day. The mouthguard can help avoid laceration in the mouth from the brace; to avoid damage to the brace and prevent injury to the teeth.



FREE Shock Doctor Patient leaflets with your order

Ideal for your waiting room. Explains to your patients what they need from a mouthguard.

Code (Pk 25)

TOC-SDW

Ortho-Channel

Integrated Ortho-Channel fits securely over braces, protecting the mouth from lacerations and provides an instant fit

Insta Fit

Fits right out of the box! No boiling or custom fitting required



BRACES DOUBLE

With all the benefits of the single braces plus:

Double Protection

Fits and protects around the upper and lower brackets.

Double Comfort

Breathing channel through the centre of the mouthguard allowing for freer flow of air and easy breathing.

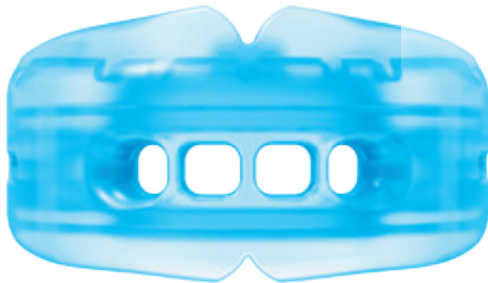

Product	Code
Double U/L - Blue	TOC-EZ4300
Double U/L - Pink	TOC-EZ4400

Shock Doctor have so much faith in their product - the Braces mouthguard comes with a Dental Warranty of up to \$10,000 per incident.



V1.5 -The Good All Rounder

Suitable for brace and non-brace wearers

The V1.5 is a Shock Doctor patented design which assists in preventing jaw fractures by acting as a cushion between the upper and lower jaw. Thus it absorbs and deflects the impact of force.

It is suitable for most sports featuring a built-in breathing channel, jaw pads and is latex free making it supremely comfortable and secure.



The V1.5 comes with a Dental Warranty of up to \$7,000 per incident

Product	Code
White/Black	TOC-EZ4000A



GEL-MAX

Mouthguard for after-brace treatment

Keep the Perfect Smile

Always regarded as a premium mouthguard - Shock Doctor have made the GEL-MAX even better! They have improved the gel-fit liner where your teeth sit allowing the GEL-MAX to fit easily without sacrificing any of the comfort or protection. Always reliable, never-fail GEL-MAX Mouthguard.

Exoskeletal Shock Frame™

Heavy duty rubber frame provides impact protection.

Gel-Fit™ Liner

Custom moulds to teeth for a tight, comfortable fit. Superior fit ensures retention and comfort while protecting against internal oral lacerations.

Multi-Layer Construction™

Our Multi-Layer Construction with an internal shock-absorbing frame offers protection and fit that outperforms conventional mouthguards.

- Suitable for all sports
- Not suitable for brace wearers

The **GEL-MAX** comes with a Dental Warranty of up to \$10,000 per incident

Product	Code
Gel Max - Blue/Black	TOC-EZ6100A
Gel Max - Blue	TOC-EZ6150A
Gel Max - Pink	TOC-EZ6200A
Gel Max - Black	TOC-EZ6210A
Gel Max - Orange/Black	TOC-EZ6230A
Gel Max - White/Clear	TOC-EZ61950A



SHOCK DOCTOR DISPLAY UNIT

Shock Doctor have developed a new display unit that will look great in your practice and help you promote mouthguards to your patients.

Flat packed, the unit is easy to assemble and is flexible in design to carry all the mouthguards in the range.

There is also space behind to store a small amount of additional stock.

Available **FREE** when you purchase Shock Doctor Mouthguards - Phone for details

Code
TOC-EZCDU



Ideal® Brace Guards

- Dual Arch Mouthguard designed specifically for upper and lower arch protection
- Manufactured from a medical grade resin that can be heated and customised, making it soft enough to protect the gingival, but tough enough to stand up to hard use.
- Small and regular sizes available.

See p107 for Effer-ves mouthguard cleaner

DENTSPLY
GAC



Product (Pk 10)	Regular	Small
Yellow	17-999-03	17-999-13
Silver	17-999-05	17-999-15
Clear	17-999-07	17-999-17

Breathable Brace Guards

- Innovative design provides upper and lower arch protection from braces while playing non-contact sports.
- Three breathing vents located at the front allow optimum airflow while playing sports.
- Increased clearance for the tongue, which fits comfortably between the bite pads.



Product (Pk10)	Code
Clear	17-999-20
Black	17-999-21
Green	17-999-22
Silver	17-999-23
Yellow	17-999-24
Multi-Colour Pack	17-999-25

Tooth Mousse

Reverse the effects of decalcification

Tooth Mousse is a unique water based, sugar free topical cream containing Recaldent™ (CCP-ACP) which is derived from the milk protein, casein.

Tooth Mousse delivers bio-available calcium and phosphate into the tooth structure to repair and strengthen enamel and dentine. White spot lesions can be avoided by using Tooth Mousse twice daily during orthodontic treatment. Easy to apply - just use a finger or interdental brush after tooth brushing allowing 3-5 minutes working time.

- Restores lost minerals
- Protects teeth from decay and decalcification
- Strengthens tooth enamel
- Reduces sensitivity
- Neutralises acid pH
- Water based and sugar free

GC



Assorted packs contain 2 x 90mg tubes of each flavour: mint, strawberry, tutti frutti, vanilla & melon.

Product (Pk10)	Code
Tooth Mousse, Assorted	TOC002032
Tooth Mousse, Mint	TOC002522

Ortho Hygiene Kit

A real quality hygiene kit to help promote good oral hygiene for those patients with fixed appliances. These sturdy, attractive kits are ideal for storage and travelling and are suitable for both teenagers and adults.

Why not take advantage of our personalised imprinting service to help you promote your practice at no extra charge. Available on orders of 144 or more.

Ortho Hygiene Kits Contain:

- V-Trim Toothbrush
- Travel Brush
- End Tuft Brush
- Mirror
- Toothpaste
- Interdental Brush
- Wax
- Timer

Product	Code
Pink	TOC-OKPK
Green	TOC-OKG
Blue	TOC-OKB
Purple	TOC-OKP



Ortho ReadyBrush™



A must have in any practice. Ready brushes come impregnated with mint toothpaste and are ready for use, just add water. Encourage your patients to brush before their appointment by offering them a Ready Brush. The V-Trim brush is designed specifically for ortho treatment to avoid interference with the appliance.

Code (Pk 30)
TOC-ORB

Chewies

Aligner Chewies are a cleaner, more professional alternative to cotton wool rolls; they help the patient seat the aligner by providing uniform force. Easy for the patient to use and re-use at home. Supply them as part of their Aligner Hygiene Care Kit.

Packaged in 10 bags of 2 in a variety of colours.



Product (Pk 20)	Code
Green - Mint	17-111-15
White - Unscented	17-111-16
Purple - Grape	17-111-17
Pink - Bubblegum	17-111-18
Yellow - Pineapple	17-111-19

TePe® Interdental Brushes

For effective cleaning around brackets & wires



Product (Pk 8)	Code
Pink - xxxx Fine	TOC-TP040
Orange - xxx Fine	TOC-TP045
Red - xx Fine	TOC-TP050
Blue - x Fine	TOC-TP060
Yellow - Fine	TOC-TP070
Green - Medium	TOC-TP080
Purple - Large	TOC-TP11
Grey - X Large	TOC-TP13

4-Tufted Brush

Ideal for cleaning around wires and brackets, this small tufted shaped brush allows easier access than a normal brush head in hard to reach areas.



Code (Pk 12)
TOC-4TUFT

Outie Tool

Easily and safely removes aligners and retainers

In order for a aligners and retainers to work correctly they need to have a tight fit which sometimes presents a problem when the patient needs to take them out for cleaning or eating. Patients have reported cases of sore fingers, broken finger nails and the use of unorthodox tools with the possibility of damaging the aligner, or much worse, a tooth.

The Outie Tool makes it easy for patients to remove their retainers and aligners safely and hygienically. With a lever design on the proximal end for fully engaging and removing the lower appliance and a hook design on the distal end for the upper appliance.



Code (Pk7)

PO-000-07

Easy Lift

Aligner & retainer remover

High quality steel alternative to the Outie Tool. Easy Lift makes it easy for patients to remove their aligners. The delicate rounded hook of the Easy Lift can be placed comfortably at the edge of the aligner so removal is easy.

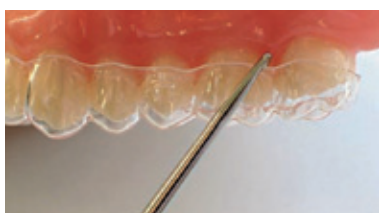

Code

TOC-EL

Comfort Cover

The ideal alternative to relief wax

Comfort Cover shields the patient's lips and cheeks from the discomfort often associated with orthodontic treatment or activities where the risk of oral laceration could occur, such as playing musical instruments or light contact sports where mouthguards are excessive.

Each patient set of Comfort Covers protects both the upper and the lower arch and is latex free.

- Packaged for professional presentation to your patients
- Great for carrying in book bags, handbags or gym bags



Product

Patient Set (Pk 5)

Code

98165

Retainer Retrievers

Retainer Retrievers help your patients remove their appliances from the buccal side, both cleanly and efficiently. They are a handy size and can be stored in an appliance case or on a key chain with the hole provided. Hygienically packaged in individual bags.



Product (Pk 10)

Tropical Blue

Code

97-000-00

Tropical Pink

97-000-01

Typodonts

High quality consultation model which may also be pre-bonded with the brackets of your choice for an additional cost



Product

Class 1 Ideal Arch

Code

TYP601

Patient Relief Wax

Plain wax in scented and coloured cases. Provides instant relief for your patients from the irritation of their fixed appliance.



Coloured Cases (Pk 50)	Code
Silver	PW-010-50
Tropical Sparkle Green	17-222-31
Tropical Sparkle Pink	17-222-32
Tropical Sparkle Blue	17-222-33
Tropical Sparkle Orange	17-222-34
White	17-222-22

Scented Cases (Pk 50)	Code
Grape (Purple)	PW-001-50
Orange (Orange)	PW-002-50
Cherry (Red)	PW-003-50
Cinnamon (Brown)	PW-004-50
Mint (Green)	PW-005-50
Bubble Gum (Pink)	PW-007-50
Pineapple (Yellow)	PW-008-50
Blueberry (Blue)	PW-009-50
Cotton Candy (Light Pink)	PW-013-50



Orthosil™ Relief Silicone

For temporary relief from appliance irritation

- Will not melt or dry out
- Great for adults
- Transparent and waterproof
- Resistant to hot liquid
- Added protection for athletes
- Longer lasting than regular wax



Product (Pk 50)	Code
Assorted	17-222-00

Gishy Goo

Silicone bracket relief aid

Gishy Goo is a specially formulated poly-vinyl-siloxane elastomer that can be placed over patient's wires and brackets to alleviate pain and discomfort. Gishy Goo is tooth coloured and is available in single patient kits or 50-syringe economy packs.

- Easy to apply
- Reduces costly emergency appointments
- Stays in place for up to 12 hours
- Helps to relieve the pain and discomfort of poking wires and rubbing braces

Easy to use: Just squeeze a little out and mix it together with your fingertips for approximately ten seconds. Place in the area of discomfort and allow to set for approximately 2 minutes.

Intro Pack
Includes 10 patient kits of 1 Gishy Goo syringe & 1 opal pix



Product	Code
Gishy Goo Single Patient Kit	500-006
Gishy Goo Intro Pack (10 Patient Kits)	500-011
Gishy Goo Economy Pack (50 Syringes)	2749

Deluxe Sparkle Retainer Cases

These superb quality retainer cases are impact resistant and will ensure retainers are kept safe. Vented for improved hygiene, they also feature a positive lock closure. With a depth of 1¼" the cases will fit most appliances. Your patients will just love these colours!

DENTSPLY
GAC



Product (pk10)	Code	Product (pk 10)	Code
Sparkle Blue	12-100-02	Tropical Sparkle Blue	12-100-12
Sparkle Green	12-100-03	Tropical Sparkle Green	12-100-13
Sparkle Red	12-100-05	Tropical Sparkle Orange	12-100-14
Sparkle Black	12-100-06	Tropical Sparkle Pink	12-100-15
Sparkle Purple	12-100-07	Glow in the Dark	12-100-09
Sparkle Gold	12-100-08	Glow in the Dark Orange	12-100-21
Sparkle Violet	12-100-10	Glow in the Dark Pink	12-100-22
Sparkle Aqua	12-100-11	Glow in the Dark Green	12-100-23

Retainer Cases

Strong, high-impact plastic in your choice of classic, glow in the dark and sparkle finishes

- Appliance key holder style
- Durable long life hinge
- 1¼" depth fits most appliances
- Vented holes prevent odours
- Write-on I.D. area



Product (pk 25)	Code
Blue	350-000
Red	350-001
Pink	350-002
Orange	350-003
Yellow	350-004
Green	350-005
Black	350-006
Clear	350-007
Aqua	350-008
Purple	350-009
Assorted	350-010
Assorted Glow	350-020
Assorted Sparkle	350-030

Appliance Cases

Slim design ideal for aligners, whitening trays and retainers. Try our pack of assorted colours so you have a colour to suit everyone!

- Strong & compact
- 1" Depth
- Positive lock hinged lid
- Vented
- Economical



Product (Pk12)	Code
Pink	TOC-RCPK
Blue	TOC-RCB
Coral	TOC-RCC
Green	TOC-RCG
Yellow	TOC-RCY
Orange	TOC-RCO
Purple	TOC-RCP
Red (Pk 10)	TOC-RCR
White	TOC-RCW
Assorted	TOC-RCA
Assorted Sparkle	TOC-RCS

Functional Appliance Cases

- Extra Deep - 1.5" deep x 3" wide x 2.5" long
- Strong hinge and secure lock protects appliances



Retainer Case (Pk10)	Code
Sparkle Black	12-200-04

Functional Retainer Cases

- 2" deep with vented holes to prevent odours
- Round with separate lid



Round Retainer Case (Pk 6)	Code
Sparkle Blue	12-200-02
Sparkle Green	12-200-05
Sparkle Orange	12-100-06
Sparkle Pink	12-100-07

Retainer Case with Mirror

- Smooth rounded compact design
- Secure snap-tight closure
- Integrated metal reinforced hinge
- Use for retainers, elastics, aligners, and more
- Durable plastic with high gloss polished finish
- 3" x 1" with 3/4" inside depth



Product (Pk 12)	Code
Black & White	45204
Assorted Colours	45205

Patient Instruction Videos

What your patients need to know about wearing braces and retainers

Created by a UK orthodontist this series of 5 videos are perfectly targeted for their audience. They are humorous and informative, providing very clear messages for children and teens on how to adapt to their new fixed and removable appliances, how to take care of them and all about wearing retainers.

Find a quiet place in your practice where your patients can watch them, then email them a link to your website a couple of days later where your patients can view them on-line as a reminder.



Featuring Vincenzo Pellegrino of 'Casualty', 'Tracey Beaker' and 'Where the Heart is' fame.



There are 5 videos:

- **The first few days:** Tells you about how your teeth will feel after your braces have been fitted, what foods to avoid, how to use wax and avoid mouth ulcers, tips to avoid breakage, how to clean your teeth with braces on.
- **Wearing your removable appliance:** Getting used to your removable appliance, guide to wearing it, how to clean it, removing your brace, what to do you if you lose or break it.
- **Wearing your twin block brace:** Getting used to your twin block brace, guide to wearing it, eating and playing sports, how to clean it, removing your brace and what to do if you lose or break it.
- **Retainers:** A guide to how long you should wear your retainers and how often, how to clean and care for your retainers, what to do about lost or broken retainers.
- **Retainers and the longer term:** Recommendations for how long you should wear your retainers once you have had your braces off.
- **Supplied on a credit card USB**

Product	Code
Patient Instruction Video USB (Set of 5 videos)	PV-100-00

TruPix™ Rhodium Coated Glass Mirrors

Superior reflectivity to chrome and metal mirrors

- High quality for the best photography results
- Superior reflectivity to chrome and metal
- Double-sided
- Incredibly smooth edges
- Autoclavable

Product	Code
Buccal Narrow	QM-800-01
Buccal Wide	QM800-02
Lingual Narrow	QM-800-03
Lingual Wide	QM-800-04
Palatal Adult	QM-800-05
Palatal Child	QM-800-06
Palatal Adult X-Long	QM-800-07



**Palatal Adult
QM-800-05**



**Palatal Child
QM-800-06**



**Palatal Adult X-Long
QM-800-07**



**Buccal Narrow
QM-800-01**



**Buccal Wide
QM-800-02**



**Lingual Narrow
QM-800-03**



**Lingual Wide
QM-800-04**

Ultrabright Glass Mirrors

These new generation dental mirrors feature a ground breaking ultrabright coating which for the first time achieves close to 100% reflectivity. The Ultrabright mirrors are single sided and come with a removable silicone handle for comfortable handling which can be autoclaved together with the mirror.

Why Ultrabright mirrors?

- Reflectivity close to 100%
- More detail for intra-oral images
- True colour representation
- High durability for repetitive autoclaving (up to 390°F/198°C)
- Best product quality

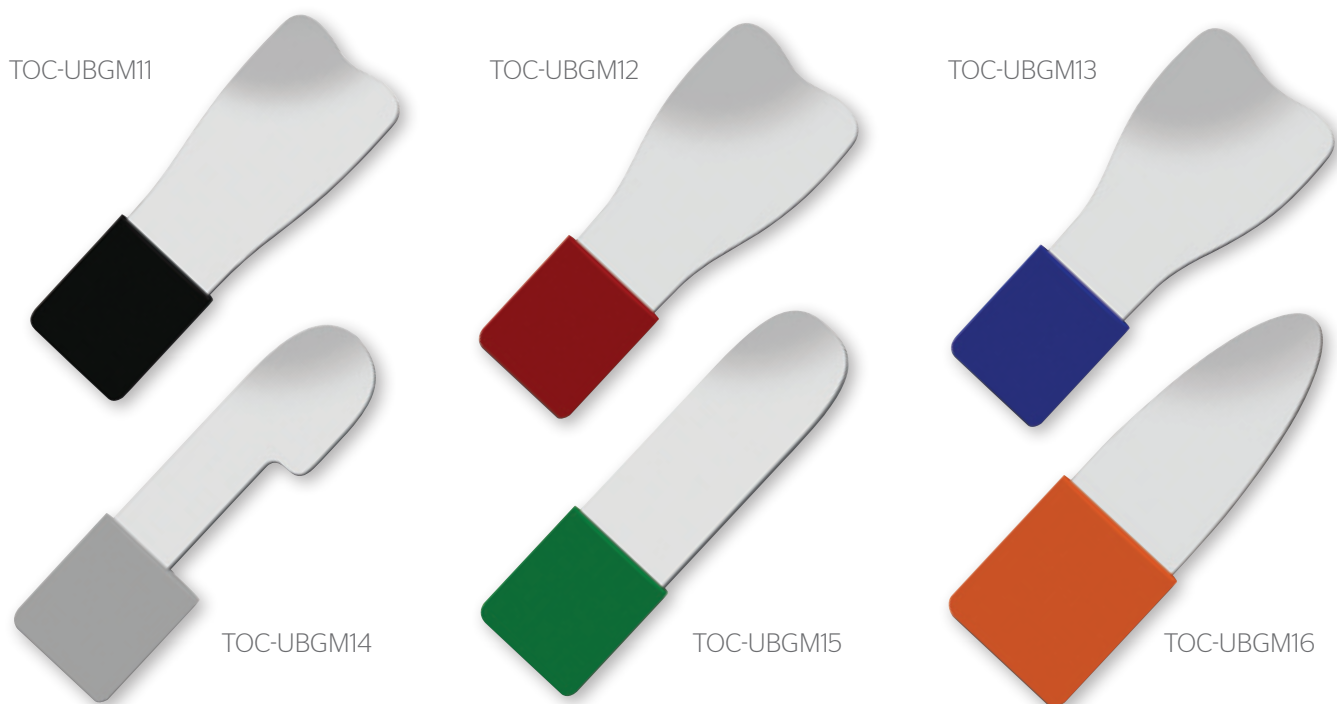

Product	Code
Child Occlusal, width 55mm	TOC-UBGM11
Adult Occlusal, width 65mm	TOC-UBGM12
Adult Occlusal, width 70mm	TOC-UBGM13
Adult Lingual, width 40mm	TOC-UBGM14
Adult Buccal, width 40mm	TOC-UBGM15
Adult Cone Shaped Short	TOC-UBGM16

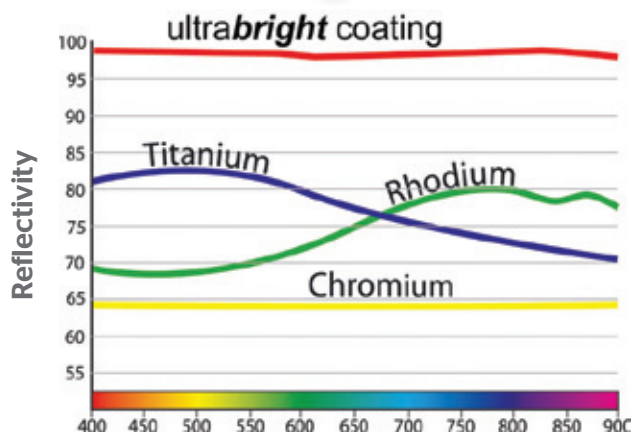

Double Sided Chrome and Titanium Mirrors

These excellent mirrors are now available in both chrome and titanium plating offering more economical choices to the Ultrabright. The titanium surface is slightly more scratch resistant than the chrome version.



Product	Chrome	Titanium
Child Occlusal, width 55mm	TOC-DRC11	TOC-DRT11
Adult Occlusal, width 65mm	TOC-DRC12	TOC-DRT12
Adult Occlusal, width 70mm	TOC-DRC13	TOC-DRT13
Adult Lingual, width 40mm	TOC-DRC14	TOC-DRT14
Adult Buccal, width 40mm	TOC-DRC15	TOC-DRT15
Adult Cone Shaped Short	TOC-DRC16	TOC-DRT16

Flexipalette Silicone Contrastors

The innovative design of the Flexipalette facilitates complete black backgrounds when taking pictures. Their ergonomic shape makes them easy to handle for both photographer and even for patients to self-position. Flexipalettes are bendable and have a soft surface that is pleasant to touch.

Made from bendable copper sheets over-moulded with Plastimed 100%, a medical grade plastic rubber, latex free and hypoallergenic, Flexipalette contrastors are completely safe for the common plastic allergies.

The black material is opaque and reflection free. Its precise texture guarantees spotless and clean black backgrounds when taking intra-oral pictures.



Flexipalette A

- Protuberance palette shape for wide shots of the upper and lower arch.
- Handle shape for easy positioning.

useful to obtain black backgrounds in occlusal shots.

- Outline "H" narrow shape for lower lip retraction and paediatric use.

Flexipalette B

- Larger round shape for large and medium arches.
- Narrow end for medium and small arches, paediatric use and lateral pictures in the anterior-posterior region.

Flexipalette Colour Match

- Provides a soft neutral intra-oral background, which will not disturb during shade taking, especially in anterior teeth (NOT for photography).
- Tool to regulate the white balance and exposure of digital cameras.
- For creative photo backgrounds.

Flexipalette C

- Outline "H" large shape for upper lip retraction and narrow regions,

- Bendable to a 30° - 45° angle to fit better into the patient's mouth
- Latex free and hypoallergenic
- Enhances digital photography of aesthetic cases
- Comfortable for the patient
- Autoclavable

Product	Code
Flexipalette Form A	FP-3001
Flexipalette Form B	FP-3002
Flexipalette Form C	FP-3003
Flexipalette Colour Match	FP-3004
Flexipalette Set of 4 (1 each)	FP-3100

Contrastors

These contrastors allow you to easily produce presentation quality images, eliminating unnecessary details such as lips from your image. The contrastors are made of anodized aluminium that are autoclavable (not cold sterilisable). The shaped handles allow the patient to easily hold them in place.



Anterior Contrastor

Anterior Width	Code
50mm - Green	ANT50
55mm - Orange	ANT55
65mm - Red	ANT65



Occlusal Contrastor

Occlusal Width (Internal)	Code
50mm - Black	OCC50
55mm - Red	OCC55
62mm - Blue	OCC62

Stainless Steel Photo Cheek Retractors

- Brushed stainless steel to reduce glare
- Double-ended with a different size on each end for adult and child
- Sterilisable up to 320°F/160°C



Product (Pk 2)	Code
Stainless Steel Cheek Retractors	LR-159-00

Photo Cheek Retractors Double Ended

- Smooth comfortable edges
- Double-ended with a different size on each end for adult and child
- Autoclavable up to 270°F/132°C
- Heat Sterilisable up to 370°F/188°C



Product (Pk 2)	Code
Double Ended - Autoclavable	QC-400-01
Double Ended - Heat Sterilisable	QC-400-02

Photo Cheek Retractors

- High quality, double ended
- Sturdy plastic will not crack
- Double ended for adult and child sizes
- Smooth rounded edges for patient comfort
- Autoclavable up to 250°F/121°C



Product (Pk 2)	Code
Photo Cheek Retractors	LR-155-00

Retract-EEZ® Photo Lip Retractor

- Allows unrestricted access
- Perfect for occlusal photographs and quick direct bond repair
- Extremely comfortable for patients
- Angled head retracts lips
- One size fits most

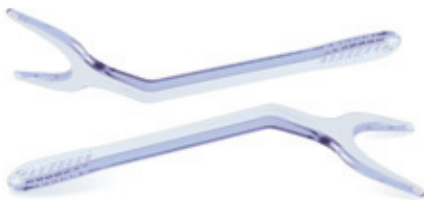

Code (Each)
QL-500-01

Long-Handled Photo Cheek Retractors

- Strong clear plastic
- Comfortable with smooth edges
- Autoclavable up to 270°F/132°C
- Adult and child sizes

Product (Pk 2)	Code
Small	QC-300-01
Large	QC-300-02



Evacu Cheek Retractor

The Evacu evacuation and cheek retractor is used in conjunction with high volume evacuation to ensure a moisture free field during bonding, with less need for chair side assistance. Autoclavable up to 230°F/110°C.



Code (Each)
TOCEV-00-01

Cheek Retractors

The longer extension tabs allow the cheeks to be pulled back further providing maximum access for easier photography. Fully autoclavable up to 230°F/110°C.



Code (Each)
TOCCR-00-01

Optragate® Extra Soft Lip and Cheek Retractor

Optragate ExtraSoft is flexible and elastic allowing unimpeded jaw movements during the entire procedure. It's latex free so is suitable for use with latex allergic patients and staff.

- Single use
- Improved patient comfort
- Full view of oral cavity



Product (Pk 80)	Code
Assorted	TOC577275
Junior	TOC591451
Regular	TOC590850
Small	TOC590851



Slim - Elegant - Beautiful

Tennis instruments - starts with a great design, the finest materials and a commitment to quality. Tennis instruments are meticulously handcrafted with up to 30 painstaking steps and multiple inspection points. Tennis combines aesthetic beauty, great durability and ease of use - perfect for the modern orthodontist.

High Quality European Stainless Steel

Tennis are carefully constructed from high quality European medical grade stainless steel to guard against corrosion and to ensure long life and superior performance. Every Tennis instrument is thoroughly tested and inspected so you can be assured of the highest quality at your fingertips.

Attractive Lustre Finish

Tennis features an attractive two tone design. The main body is satin finished to be non-reflective and reduce glare. The highly polished handle ends of labial instruments and black lingual handles make for easy identification.

Dependable Orbit Joint

The smooth, durable orbit joint is one of the reasons you'll enjoy reliable performance. This joint protects against debris intrusion and promises dependable alignment of the tips to give you reliable cutting or wire forming.

User Friendly Ergonomic Design

Tennis provides safety and comfort for you and your patient. With their ideal size and smooth, rounded edges Tennis are safe in operation and a pleasure to use.

Permanent I.D. Marking

Tennis instruments are engraved with the recommended wire capacity to help you choose the right instrument for each procedure, every time.

Inserted Tips

Tennis cutters feature extra hard Resist™ Stainless Steel inserted tips. Resist™ undergoes several steps to achieve the ideal hardness necessary for reliably cutting orthodontic archwires.

- **5 year warranty**
- **Resist™ Stainless Steel cutting tips for reliability and superior cutting action**
- **Ergonomic Design**
- user friendly
- **Satin finish to reduce glare**



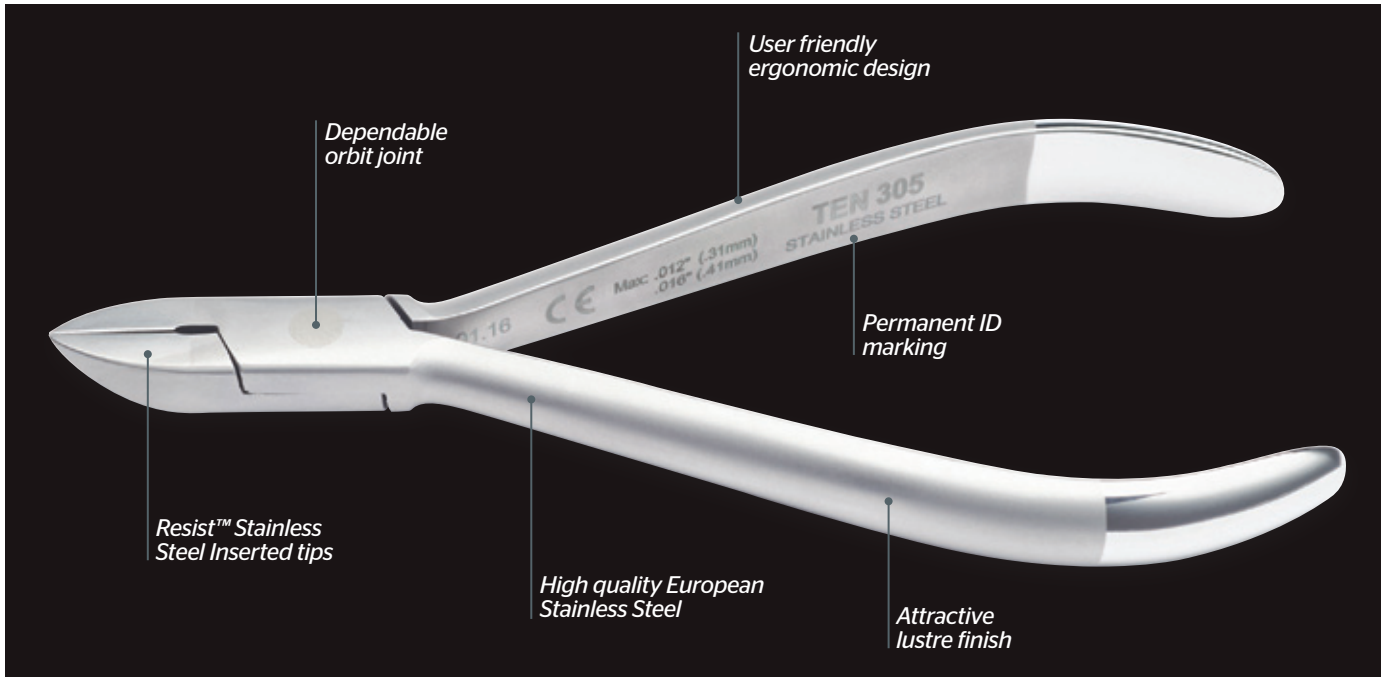

CUTTERS



Safety Hold Distal End Cutter

For safe intraoral use, shear cuts and securely holds wire from .012" to .021" x .025".

Code

TEN301

TEN301XL (Long Handle)



Hard Wire Cutter

Specially designed to cut wires up to .022" x .028" and hard wires to .022"

Code

TEN304



Pin and Ligature Cutter

A standard non angulated pin and ligature cutter for use on soft wire from .012" to .016".

Code

TEN305



Mini Pin and Ligature Cutter

Cuts soft wire up to .012" with the slim tips making it easy to use in awkward areas.

Code

TEN306



Micro Mini Pin and Ligature Cutter

Extra slim cutter designed for even easier access in constricted areas, for soft wire up to .012".

Code

TEN307



Micro Mini Pin and Ligature Cutter, 15° angled

With its 15 degree angled tip this cutter allows easier access in difficult areas and better visibility. Cuts soft wires up to .012".

Code

TEN309

PLIERS

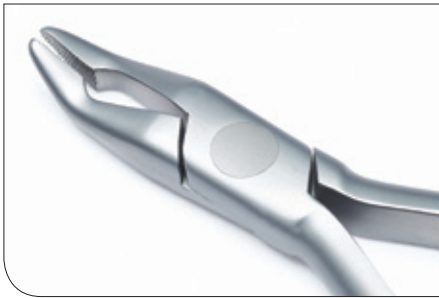

Weingart Plier

The serrated beaks grip archwires firmly and the angled tips fit easily into difficult areas. A general utility plier with many practical uses.

Code

TEN302 (Standard)

TEN303 (Slim)



Three Jaw Plier

For adjusting and contouring archwires, clasps and retainer wire up to .030" without damage. The tapered beaks allows for delicate bending.

Code

TEN312



Adhesive Removing Plier

Superior tip design allows easy access to remove excess adhesive after debonding.

Code

TEN316



Band Removing Plier

For the safe and quick removal of posterior bands. The pointed beak slips under the band while the plastic tip protects the occlusal surface of the tooth. For easy band removal, patient comfort and enamel damage prevention.

Code

TEN317



Rectangular Arch Forming Plier (Tweed)

Great for bending and torquing archwires with no damage. For archwires up to .022" x .025".

Code

TEN318



Bracket Remover - Straight

The sharp tips wedge between the edge of bracket base and tooth surface, lifting off the bracket with no patient discomfort. The tips grip securely for reliable horizontal or vertical removal.

Code

TEN319



Bracket Remover - Angled

Similar to TEN319 but with angled beaks for easier access in difficult to reach posterior brackets.

Code

TEN320



Loop Forming Plier

Ideal for making precise loop in .045", .060" & .075" diameters in archwires up to .022" x .025".

Code

TEN326



Hammerhead NiTi Cinch Back Plier

Cinches and bends NiTi archwire intra-orally distal to the buccal tube with no heat necessary. For archwires up to .025". Slim tips allow for precise working.

Code

TEN327



Light Wire Plier

Has tapered beaks which allow intricate bends and loops to be made in archwires up to .020". The smooth un-grooved beaks make it ideal for bending light wires.

Code

TEN328



Hook Crimping Pliers

Easily and quickly crimp stops, hooks and posts to the archwire. Slot fits over base of hook while holding it tight for crimping.

Code

TEN329



Bird Beak Plier

A very popular utility plier for all types of wire bending. Features round and pyramidal tapered tips to work round, square and rectangular archwire up to .30".

Code

TEN330



How Utility Plier

A handy utility plier that features serrated tips for a firm grip. Great for placing and removing archwires, pins and auxiliaries.

Code

TEN333

See
p139 for
Instrument
Organisers



Slim - Elegant - Beautiful

Tennis Lingual is a range of instruments designed specifically for lingual use. Beautifully crafted in high quality stainless steel, Tennis Lingual provides you with all you need to carry out lingual treatment with the brackets of your choice.

To work on the lingual of the teeth, instruments must have fine tips and subtle curvature of the working ends - all features of Tennis Lingual.

Each instrument is a pleasure to use because of the comfort afforded the clinician and the patient. This is achieved through the smooth shape of the handles, the fine curved working tips and the satin finish to reduce glare. Long handles make Tennis instruments ideal for working in the confined lingual area.

Tennis Lingual instruments feature an orbit joint for reliability and smoothness of operation so you can trust the tips meet perfectly time after time. This design improves their ability to withstand the demands of sterilisation.

For peace of mind all Tennis Lingual cutting tips are made of Resist™ Stainless Steel which gives the cutters strength, reliability and superior cutting action.

Tennis Lingual instruments are uniquely identified by satin black handle ends so you can easily distinguish them from your labial instruments.

All Tennis Lingual instruments are designed to provide operational excellence and deliver the promise of quality instrumentation.



**3 Year
Warranty**



- **3 year warranty**
- **Resist™ Stainless Steel cutting tips for reliability and superior cutting action**
- **Satin black handles for easy identification**
- **Satin finish to reduce glare**
- **Fine tips and long handles specifically designed for lingual use**





Distal End Cutter with Safety Hold - Flush Cut

Bring an end to patient discomfort with this specially designed flush cut safety hold cutter. Cuts wire flush to end of buccal tube so no excess wire can impinge on soft tissue.

Code

TEN323LG (wires .016" to .021"x .025")

TEN323BLG (wires .012" to .016"x .025")

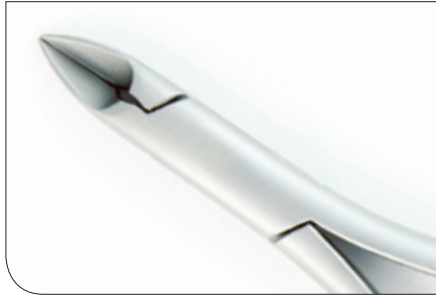

Ligature Cutter

Easy to use when cutting ligature wires/ elastics. Wire capacity up to .012".

Code

TEN331LG



Angled Ligature Cutter

Easy to use when cutting ligature wires or elastics. Angled option for easier access to lingual arches. Wire capacity up to .012".

Code

TEN322LG (Angled)



Weingart Pliers

Useful utility pliers with a 60 degree angle making them ideal for lingual use. Carefully finished slim beaks for confident use in confined areas.

Code

TEN377LG



Debonding Pliers

Fine tips makes removal of lingual brackets so much easier and more comfortable for you and your patient.

Code

TEN380LG



NiTi Distal Cinch Back Pliers

Bends NiTi wire distal to the buccal tube for patient comfort. Serrated tips grip wire securely. Wire capacity .012" to .018".

Code

TEN802LG

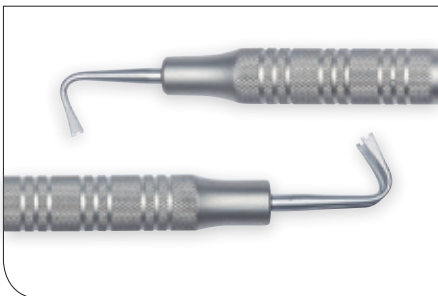

Lingual Wire Placer

Aids wire placement in lingual brackets whilst closing clips or ligating brackets. Specially shaped angled ends helps to maximise view. One single and one double end allows flexibility of use and the large diameter handle makes it easy to grip.

Code

TEN100LG



Mosquitos Curved

Angled for ligating in posterior and lingual areas with serrated tips for a positive grip of elastic ligatures.

Code

TEN101

WARRANTY POLICY

Tenis Labial Instruments are guaranteed for 5 years and Tenvis Lingual for 3 years. This covers corrosion, joint failure and breakage during normal use. Proper cleaning and maintenance is required to maintain the warranty. This warranty may be void if the incorrect sized wires are used for cutting or if the instruments are not properly cared for, including cleaning and lubrication. TOC reserves the right to decide whether an instrument is to be repaired or replaced. Sharpening of cutting instruments and repairing minor tip damage is not covered by warranty as it is considered routine maintenance for normal use.

essentials™

Value Instrument Range

Essentials instruments are made of surgical grade stainless steel which is highly resistant to corrosion. The precise tip alignment and diamond honed edges ensures reliable cutting and holding of wires. Balanced joint assembly and well finished handles means Essentials instruments are easy and comfortable to use.

All Essentials instruments have an attractive satin finish so glare is reduced and the instruments have a pleasing quality look with no possibility of chrome plating peeling off. The cutters feature hardened steel tips for maximum performance. For safe use, cutting instruments are engraved with the maximum wire size to be used.

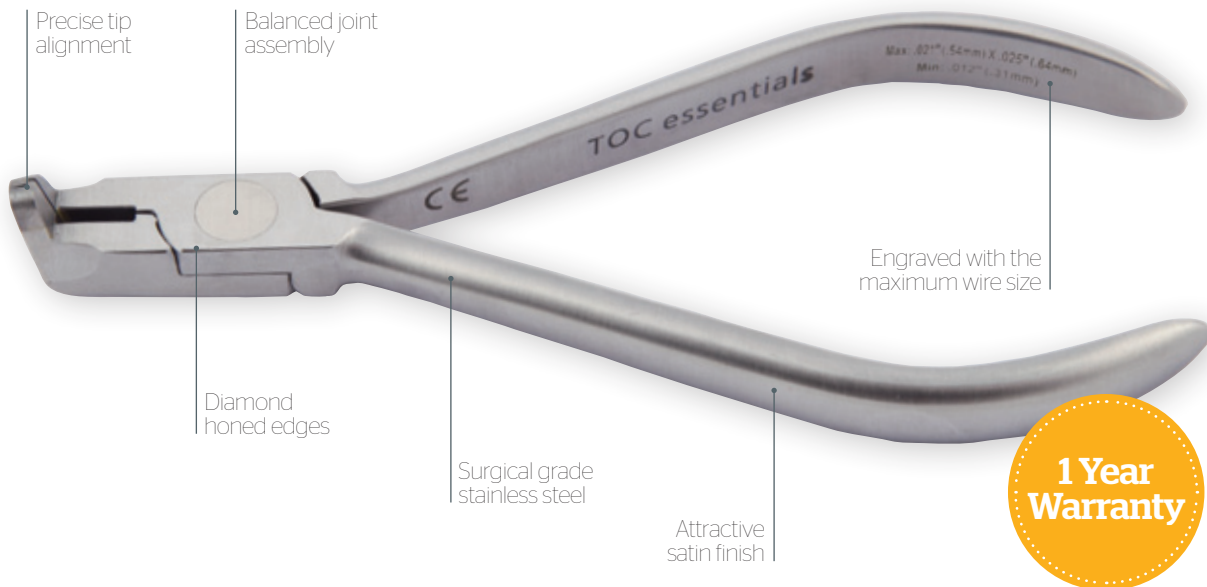

Value Cutters



Distal End Cutter

Safety hold cutters with immunity steel tips that will not discolour or rust. Cuts .018" x .025" and .022" hard wires.

Code

TOC-E0319



Hard Wire Cutter

Specially designed for cutting hard wires. Cuts .022" x .028" and .022" hard wire.

Code

TOC-E0353



Pin and Ligature Cutter

A standard pin cutter with tips that have an ideal length of 12mm. Cuts .012" to .016".

Code

TOC-E0330



Adhesive Remover

Tip design allows access to remove adhesive in practically any area of the mouth. Replaceable teflon pad withstands high heat sterilisation.

Code

TOC-E0427



Straight Bracket Remover

Sharp tips wedge between the edge of the bracket base and tooth surface lifting off the bracket with no discomfort to the patient. The removers grip firmly for easy horizontal or vertical use.

Code

TOC-E0381



Angled Bracket Remover

Same as TOC-E0381, but angled for easy access to difficult posterior areas.

Code

TOC-E0380

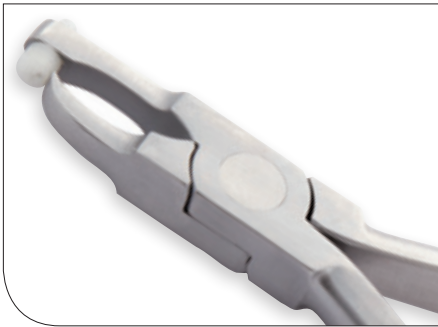

Short Band Removers

The padded tip rests on the occlusal surface whilst the pointed tip catches the edge of the band for upward or downward removal.

Code

TOC-E0373



Long Band Removers

Same as TOC-E0373, but with a longer remover tip. High heat replaceable pads available in 4, 5 and 6mm diameter.

Code

TOC-E0371

WARRANTY POLICY

Essentials Instruments are guaranteed for 1 year. This covers corrosion, joint failure and breakage during normal use. Proper cleaning and maintenance is required to maintain the warranty. This warranty may be void if the incorrect sized wires are used for cutting or if the instruments are not properly cared for, including cleaning and lubrication. TOC reserves the right to decide whether an instrument is to be repaired or replaced. Sharpening of cutting instruments and repairing minor tip damage is not covered by warranty as it is considered routine maintenance for normal use.

Value Pliers



Weingart Plier

General utility plier with serrated tips to hold archwires firmly in the mouth. Angled for ease of working and good access.

Code

TOC-E0377



Slim Weingart Plier

General utility plier with slimmer tips for easier access to difficult areas. Serrated tips hold archwires firmly in the mouth.

Code

TOC-E0375



Three Jaw Plier

For adjusting clasps, retainers and archwires. With perfectly aligned tips which are tapered for delicate bending. Bends wire up to .030"

Code

TOC-E0385



Tweed Arch Forming

Designed for double back or triple back wire bending and can accommodate .030", .036" square wires. Also ideal for torquing.

Code

TOC-E0412



Crimping Plier

For crimping crimp stops, hooks and posts to the archwire. The slot fits over the base of the hook while holding it tight for crimping.

Code

TOC-E0901



Step Forming Plier

Make right or left, step up or step down bends in one simple action. Can be used intra-orally so no need to remove the archwire. The 3 sizes allow you to apply the precise amount of bend required. Also able to intrude or extrude a tooth or teeth and change inclination or rotation.

Size	Code
0.5 mm	TOC-E0712
0.75 mm	TOC-E0711
1 mm	TOC-E0710



Cinch Back Plier

Cinches and bends NiTi archwires distal to the buccal tube. Slim beak allows precise working.

Code

TOC-E0802

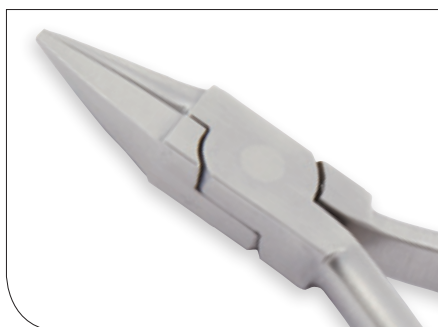

Light Wire Plier

With tapered beaks for forming precise bends and loops in round archwires up to .020".

Code

TOC-E0392



How Utility Plier

Features straight serrated tips for a firm grip. Tips are 3mm diameter.

Code

TOC-E0432



Bird Beak Plier

Facilitates bending round wire up to .030". Features hardened tips.

Code

TOC-E0390



Adams 64 - Utility Plier

For adjusting orthodontic appliances.

Code

TOC-E0064



Adams 65

Square and rounded tips for forming springs and curves in wires.

Code

TOC-E0065

Premium Hand Instruments



Manufactured from high quality stainless steel

- Ergonomically designed for maximum comfort and reduced muscle fatigue
- Textured grip for easy handling and control

Tenvis Explorer

Code

TEN220



Tenvis Ligature Director

Code

TEN221



Tenvis Direct Bond Adhesive Remover

Code

TEN222



Tenvis Twirl-On Module

Code

TEN223



Tenvis Distal Bender, Double Ended

Code

TEN224



Tenvis Lingual Wire Placer

Aids wire placement in lingual brackets whilst closing clips or ligating brackets. Specially shaped angled ends helps to maximise view. One single and one double end allows flexibility of use and the large diameter handle makes it easy to grip.

Code

TEN100LG



TN3 Bracket Positioner

For easy bracket positioning and clean up. The TN3 is a double ended tool that has on one end a hockey stick shaped positioning blade with laser etched scribe line for precise placement of brackets and at the other end a scaler for easy clean up of flash.

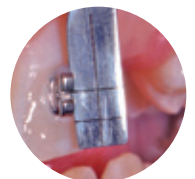

Code

ODG520



Flat Plastic Instrument

Code

TOCFPI



Long Probe - Single Ended (No. 6)

Code

TOCLPSE



Short Probe - Single Ended (No. 37)

Code

TOCSPSE



Mitchells Trimmer

Code

TOCMT



Self-Ligating Bracket Instruments

Engage-R Tool

The dual tips on one end span the In-Ovation R bracket to grab the arch wire, allowing you to easily snap the clip closed. The other end has a small ball that fits perfectly into the sliding cap for easy opening.

Code

ODG88005



Beaver Tail

The Beaver Tail has a flat end for opening the In-Ovation R clip and a forked end for seating the wire before closing the clip.

Code

ODG88001



Engage-C Tool

The dual tips on one end span the In-Ovation C bracket to grab the arch wire, allowing you to easily snap the clip closed. The other end has a small "cup" that fits perfectly over the ball of the sliding clip for easy opening.

Code

ODG88008



In-Ovation Mini Clip Opener

Round metal blade in a plastic handle used for opening the In-Ovation Mini bracket. Available singly or in packs of five.

Code (Each)

07-1910101

Code (Pk 5)

07-191010



In-Ovation L/MTM Tool

A small curved scaler for opening In-Ovation L and MTM self-ligating clips from facial aspect of the bracket.

Code

GAC890



Hand Instruments

Direct Bond Instrument

High quality bracket tweezer which holds any bracket, whatever size. The reverse action will not release the bracket until desired - it can easily be pre-loaded as needed.

Code
ODG500



Curved Direct Bond Instrument

Ideal for placing lingual brackets, bite bumpers and other attachments.

Code
TEN232



Keat Buccal Tube Tweezers

For easy and accurate positioning of buccal tubes. Reverse action will not release the tube until required.

Product	Code
Keat Buccal Tube Tweezers	TEN230
Reverse Action Tweezers	TEN231



Direct Bond Tweezers with Bracket Aligner

Reverse action tweezer for placing brackets, with slot aligner on the opposite end.

Code
TEN233



Direct Bond Tweezers

For bracket placement. Reverse action will not release the bracket until desired.

Code
TEN234



Positive Positioner

Specifically designed for placing direct bond tubes or attachments. With a spring loaded mechanism and serrated tips for positive gripping. Made of lightweight aluminium.

Code
SP-222-00



College Tweezers

Ideal length for comfortable fit with angled serrated tips

Code
TOC-255



Value Hand Instruments

essentials™

Offering great value for money, the Essentials range of Hand Instruments are manufactured from high quality stainless steel and are resistant to corrosion.



Mosquito

Straight tip with a length of 12.5cm. Grooved tip for placement of elastic ligatures.

Code
TOC-E0140



Keat Reverse Action Tweezer

For easy and accurate positioning of buccal tubes. Reverse action will not release tube until required.

Code
TOC-E0455



Bonding Tweezer

Reverse action tweezer for placing brackets with slot aligner on the opposite end.

Code
TOC-E0450



Curved Bonding Tweezer

Ideal for placing lingual brackets and attachments. Reverse action.

Code
TOC-E0510



Bonding Tweezer - Standard

For bracket placement. Reverse action will not release the bracket until desired.

Code
TOC-E0451



Band Pusher

With serrated tip to reduce risk of slippage. Light weight hollow handle for easy working.

Code
TOC-E0477



Bonding Tweezer - Fine Tips

Extra fine tips for extra visibility. With slot aligner on the opposite end.

Code
TOC-E0452



Separating Plier

Grooved beaks ensure a positive hold for positioning elastics. Angled tips for ease of access.

Code
TOC-E0585



Keat Tweezer

For easy and accurate positioning of buccal tubes.

Code
TOC-E0454



Ligature Director

Double ended light weight ligature director with textured grip.

Code
TOC-E0478

Assorted Hand Instruments



High Heat Bite Stick

- Metal serrated triangle tip
- Molded high impact plastic
- Safe for dry heat sterilisers
- Sterilisable up to 350°F/177°C

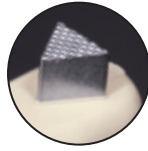

Code

SB-600-01



High Heat Bite Stick

High impact plastic handle that will not flex or bend with a stainless steel tip. Autoclavable.



Code

SB-600-02

Mathieu Hemostat Double Spring Carbide Insert

For placing elastic modules or stainless steel ties.



Code

GAC515

Colour Coded Bite Sticks

Molded high impact plastic with metal serrated triangle tip.

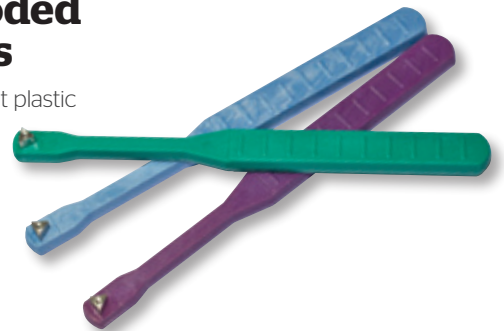

Autoclavable up to 250°F/121°C. Do not cold sterilise.

Product

Code

Teal

SB-600-03

Purple

SB-600-04

Blue

SB-600-05

Mathieu Hemostat Narrow Serrated Tip

With a narrow tip for easy placement of elastic modules. The serrated tip ensures a secure grip.



Code

GAC503

Premium Mosquito Hemostat

Developed for ease and assurance in placing of elastic ligatures. Precision tips and locking handles provide a positive, non-slip grip. Narrow tip.

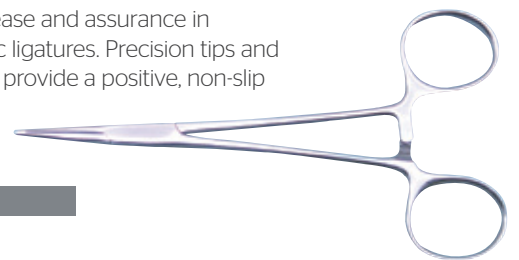

Code

TOC200-128

Tennis Curved Mosquito Hemostat

Curved for ligating in posterior and lingual areas with serrated tips for a positive grip of elastic ligatures.



Code

TEN101

Mosquito

Straight tip with a length of 12.5cm. Grooved for placement of elastic ligatures.

essentials™



Code

TOC-E0140

Overbite Ruler

Aluminium ruler for easy measuring of overbite. Cold sterilisable.



Code

TOC-OBR100

Ruler

Double sided with one side metric and the other Imperial

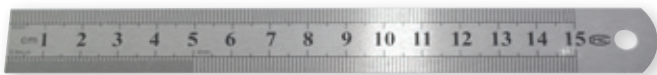

Code

TOCSSR

Disposable Mouth Mirror

- Prevents cross contamination
- Sterile packed single use



Code (Pk 200)

TOCDMM

Cephalometric Tracing Pad

This 100-page tablet contains 8" x 10" acetate sheets that resist tearing and curling. Each sheet is .003" thick and is protected by tissue paper inserts.



Code (Pk100)

17-222-11

Measuring Dividers

With a centre adjusting screw for a quick and accurate measuring intra-oral or on models



Code

TOC-DIV

Aluminium Height Gauge

Measures height of bracket placement from incisal edge. 3.5, 4, 4.5, and 5mm.



Autoclavable up to 250°F/121°C

Product	Code
.018"	SH-018-10
.022"	SH-022-10

High Heat Height Gauge

With the same features as the aluminium gauge at a reduced price. Withstands heat up to 350°F/177°C.



Product	Code
.018"	SH-018-00
.022"	SH-022-00

Boone Gauge Stainless Steel

Accurately measures height of bracket placement from incisal edge. 3.5, 4, 4.5, and 5mm.



Heat sterilisable up to 370°F/188°C

Code

TEN225

Safety Swivel Key

- No fingers in the mouth
- No fear of dropping keys down patient's throat



Code

97-111-11

Elastomeric Organisers

- Keeps contaminants out
- Allows for visual inventory
- Convenient storage



A. Combination Organiser

Product	Size	Code
A.	6¾" W x 5½" H x 9" D	OT-CDW
B.	3¾" W x 4¾" H x 9¾" D	OT-PCD
C.	10½" W x 5½" H x 5¼" D	OT-PSD

B. Elastomeric Chain Organiser



C. Elastomeric Ties Organiser

See p66-71 for Elastomerics

Brackets, Bands & Wire Organisers

A. Archwire Organiser, with Lid



B. Archwire Organiser, without Lid



Product	Size	Code
A.	7¾" W x 4½" H x 4" D	OT-AWH
B.	7¾" W x 2¾" H x 4" D	OT-AWHS
C.	6¼" W x 6¾" H x 4¾" D	LB-300-00
D.	Holds up to 25 brackets	PT-200
E.	Bands 11¼" W x 1½" H x 8¼" D	85180K
E.	Brackets 11¼" W x 1½" H x 8¼" D	85181K
F.	10 GAC wire pack capacity	02-500-02

C. Bonding Pad Organiser



E. Stackable Band/Bracket Organiser



D. Bracket Organiser/Prep Tray



F. GAC Pak Rack



All organisers do not include products

Instrument Organisers



A. Combination Organiser

B. Covered Plier Organiser



C. Upright Plier Organiser



D. Round Plier Organiser

E. Plier Organiser



F. Combination Rack

Product	Size	Code
A.	6½" W x 3¾" H x 9¼" D	PDW-001
B.	7¼" W x 7½" H x 6" D	56146
C.	4¾" W x 5¼" H x 9" D White	OT-IHW
C.	4¾" W x 5¼" H x 9" D Black	OT-IHB
C.	4¾" W x 5¼" H x 9" D Clear	OT-IHC
D.	4" W x 4¾" H	PDW-002
E.	14cm x 22.9cm	4150-501
F.	8.9cm x 17.8cm	4150-502
G.	15.5cm x 27cm	TOC-0601

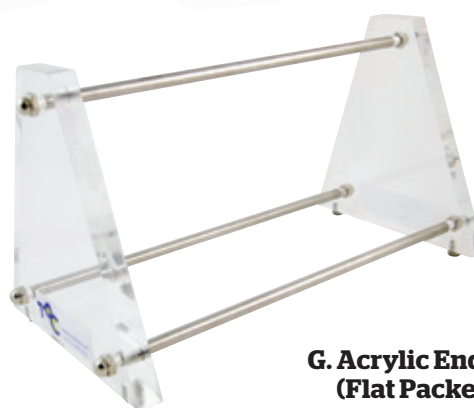

G. Acrylic Ended Plier Rack (Flat Packed)

See
p123-137 for
instruments

Instrument Sterilisation Cassettes

A range of cassettes is available for easy handling of instruments. Made of stainless steel and silicone these trays are self locking and are the safest option for instrument logistics. Contact us with your requirements.

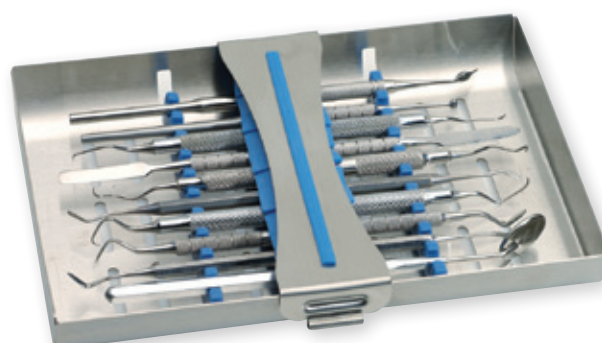

Terms & Conditions

Prices

All prices quoted are exclusive of VAT and Carriage. There is no minimum order charge. TOC reserves the right to change price details as it may deem necessary without prior notice and without incurring obligation.

Payment

Payment is to be made within 30 days from date of invoice. A statement covering all invoices is sent monthly. Goods will remain the property of TOC until payment in full has been received. Interest may be charged on overdue accounts at the rate of 3% per month. Furthermore, any costs incurred in recovering debts will be charged accordingly. Cheque, BACS, Visa, Mastercard, American Express and Maestro are all accepted methods of payment. If you have requested to pay your account with Euros, you can pay via cheque or BACS.

Delivery

TOC endeavours to despatch orders on the same day they are placed. Each delivery will contain a delivery note or invoice as well as informing the customer of any items to follow. On receipt of goods customers are requested to ensure the goods are as required before breaking any packaging or seal. Shortages or breakages must be notified to TOC within 3 days of receipt.

Quality

TOC operates a Quality Management System which conforms to all current quality and regulatory standards. This incorporates a Batch/Lot Control System for traceability of all medical devices and equipment dispatched by TOC. Customers should retain information for products supplied by TOC including Batch/Lot No. and expiry dates.

Continuing Product Improvement

Due to continuing product improvement TOC reserves the right to modify, improve and change product specification and to discontinue products without advance notice and without incurring obligation. We are not responsible for typographical or photographic errors and we reserve the right to limit quantities.

No part of TOC's catalogue, literature or website may be reproduced in any form without the permission of TOC. All images are for illustration purposes only. All trademarks are the property of their respective owners. E&OE

Please note TOC is unable to supply Eire with *DENTSPLY GAC* products.

*Thank you for
choosing TOC for
your orthodontic
requirements*



TOC © March 2017. All rights reserved.

Returns

All credits and returns are issued at the discretion of TOC Head Office. Customers must in the first instance call TOC with details of products to be returned with reasons for the return.

Under the following conditions, customers may return for credit any stock product with which they are not satisfied:

1. Products must be returned within 30 days of purchase.
2. Products must be standard catalogue items in an unopened condition and will only be accepted back from the original purchaser.
3. Written explanation must accompany the goods, stating the reason for dissatisfaction and quoting the original invoice number.
4. Returned goods must be adequately packaged to withstand delivery and carriage must be prepaid by the customer with contents insured to the full invoice value. TOC is unable to credit returned goods lost or damaged in transit.
5. All products must be in a new and resaleable condition, of current design and in its original packaging. According to CE regulations, items returned opened must be regarded as "used" and cannot therefore be accepted back for credit.
6. TOC reserves the right to charge a 15% restocking fee on certain products.
7. Special customer ordered products such as prewelded bands are non-returnable.
8. Products supplied from other companies that are not standard stock items are not returnable.

Cancellations

TOC reserves the right to cancel an order or balance of order without liability. Customers are not able to cancel orders without the agreement of TOC. A charge may be made to cover costs already incurred where special items are cancelled.

Instrument Repairs & Returns

TOC is prohibited from accepting instruments for evaluation or repair without proof of sterilisation. Please contact us to a request a sterilisation form or download one from our website. Unless proof of sterilisation is provided TOC reserves the right to either destroy these items or return them to the sender.

Law

These terms and conditions shall be governed by and construed in accordance with the law of England and the parties hereby submit to the exclusive jurisdiction of the English courts.

*Please contact TOC for disposal of any WEEE items purchased from TOC.
WEEE registration WEE/CCO209WR*



Index

A

Adhesives	72-76
Adhesive Remover	132
Air Rotor Stripping Burs	104-105
Alcohol Marking Pens	94
Alghamix II Mixing Machine	91
Alginate	89-90
Alginate Flavouring	90
Alginate Mixing Bowls & Spatulas	91
Alginate Mixing Machines	90-91
Aligner Chewies	113
Aligner System	85
Allergy Control Products	64-65
Aluminium Oxide	78
Anterior Contrastors	121
Appliance Cases	116-117
Appliance Cleaner	107
Applicators	77-78
Archwires	40-53
Beta Titanium	46
BioForce	41
Coated	51
Copper NiTi	44-45
High Aesthetic	50
Lingual	52-53
Neo-Sentalloy	40
Nickel Titanium	42-43
Posted Stainless Steel	49
Sentalloy	40
Stainless Steel	48-49
Thermal Nickel Titanium	40, 42-43
Universal Form	42, 44-45
Wildcat Twist Wire	55
Archwire Markers, Dispenser	55
Archwire Organiser	138
Archwire Sleeving	69
Archwire Stops	60
Attachments	56-60
Australian Wire	47

B

Ball Hooks	60
Bands & Buccal Tubes	33-38
Band Cement	75
Band Pusher	135
Band Storage	36, 138
Barrier Sleeve for Curing Lights	84
Base Formers	96
Beta Titanium Archwire	46
Bi-Directional Hooks	60
BioBiteCorrector	56-57
BioForce Plus Archwires	41
Bite Bumper	59
Bite Ramp, Mini-Mold Tips	80
Bite Registration	93
Bite Sticks	136
Bite Wafers	96
Bite Wax	96
Bleaching Tray Material	97
Blockout Material	99
Bondable Buccal Tubes	37-38
Bondable Buttons, Eyelets, Hooks, Cleats	59
Bondable Retainers	61
Bonding Accessories	77
Bonding Adhesives	72-76
Bonding Brushes	77-78
Bonding Kits	72-73
Bonding Pads, Trays	77
Bonding Tweezers	134-135
Boxes, Retainer	116-117

Brace Guards	108-112
Bracket Organiser	36, 138
Bracket Placers	134-135
Bracket Positioner	132
Buccal Tubes	37-38
Bumper Sleeve	69
Burs	105
Buttons	59

C

Caplin Hooks	59
Capsules, Adhesive Refills, Gun	72
Cases, Retainer	116-117
Cavex Alginate Mixer	90
Cement, Band	75
Cephalometric Tracing Pad	137
Ceramic Brackets	5-13
Chain, Elastomeric	68-69
Cheek Retractors	81-83, 122
Chewies	113
Chilling Spray	98
Chromatic Alginate	89
Class II Corrector	56-57
Closed Coil Springs	54
Coated Archwire	51
Coated Ligature Ties, Springs	55
Coil Springs	54
Cold Spray	98
College Tweezer	134
Comfort Cover	114
Comfort Fit Facemask	86
Composite Bracket	14
Composite Removal Burs	105
Consultation Models	114
Contrastors	121
Copper NiTi Archwire	44-45
Crimpable Hooks, Stops	60
Crimping Pliers	126, 131
Crystal Retainer Material	97
Curing Light & Accessories	84
Cutting Wheel	99

D

Debonding Burs	105
Dewimed TAD, OSAS	62-63
Diakleen Rubber Cleaning Block	101
Diamond Discs	106
Diamond Strips	104
Diamond Whitening Tray Material	97
Direct Bond Buttons, Cleats, Eyelets	59
Disc Guards	106
Disconnect Kits, Micro Etcher	79
Disposable Mouth Mirrors	137
Distal Bender	132
Dividers	137
Dryfield System, Nola	81
Dual Laminates	98
Dust Containment Units	78

E

Easy Lift	114
Easy Vac Vacuuming Forming Machine	99
Effer-ves Appliance Cleaner	107
Elastic Directors, Placers	70
Elastic Thread, Bumper Sleeve	69
Elastics, Intra-Oral, Extra-Oral	70-71
Elastomeric Chain	68-69
Elastomeric Organisers	138
Elastomeric Ties	66-67
Electric Heated Knife	99

Envy Composite Bracket	14
Eruption Appliances	58
Essentials Value Bondable Buccal Tubes	38
Essentials Value Instruments	129-131, 135
Essentials Value Metal Bracket	28
Essentials Value Molar Bands	36
Essentials Value Nickel Titanium Archwire	43
Essentials Value Stainless Steel Archwire	49
Essentials Value Thermal Nickel Titanium Archwire	43
Etch	74
Exabite Bite Registration Material	93
Exacto Bites	94
Exafast PVS Impression Materials	92-93
Explorer	132
Extra-Oral Elastics	70
Eyelets	59

F

Facebows	87
Facemask	86
Flat Plastic Instrument	133
Flavourings, Alginate	90
Flowable Composite	76
FlowTain Flowable LC Composite	76
Fuji Ortho LC Bracket Adhesive	74

G

Gauges, Interproximal	103
Gem Mouthguard Material	98
Ghost Advanced Polysapphire Bracket	10-11
Gishy Goo	115
Glass Ionomer Band Cement	75
Gold Chain Retainer Wire	61
Gold Eruption Chain	58

H

Hamill Safety Facebow	87
Hand Instruments	132-137
HandyStripper Kit	103
Headgear Products	86-87
Heated Knife	99
Height Gauge	137
High Aesthetic Sentalloy, BioForce Archwire	50
Hi-Q Beta Titanium Archwire	46
Hi-Q Copper Nickel Titanium Archwire	45
Hi-Q Lingual Archwire	53
Hi-Q Nickel Titanium Archwires	42
Hi-Q Reverse Curve	47
Hi-Q Stainless Steel Archwire	48
Hi-Q Stainless Steel Posted Archwire	49
Hi-Q Thermal Nickel Titanium Archwires	42
Hollow Thread	69
Hooks, Crimpable	60
Hot Knife	99
Hygiene Kits	113

I

Ice Retainer Material	97
Ideal Alginate	90
Ideal Smile Aligner System	85
Impression Supplies	88-96
Impression Trays	88-89
Indelible Pencils	94
In-Ovation C Bracket	6-7
In-Ovation L Lingual Bracket	32
In-Ovation L MTM Lingual Bracket	30-31
In-Ovation Mini Bracket	18-19
In-Ovation R Bracket	16-17
Instruments	123-137
Instrument Organisers	139
Instrument Sterilisation Cassettes	139
Instrument Storage	139
Intensiv Ortho-Strip System	101

Interdental Brushes	113
Interproximal Diamond Strips & Burs	104
Interproximal Measuring Gauges	103
Interproximal Stripping	101-104
Intra-Oral Elastics	70-71

K

Kobayashi Ligature Ties	55
-------------------------------	----

L

Laminated Bite Wafers	96
Latex Free Elastomers	65
LED Curing Light	84
Ligature Director	132
Ligature Free Brackets	6, 16, 18, 30, 32
Ligatures, Elastomers	66-67
Ligature Ties, Wire	55
Light Cure Adhesive	72-74
Light Cure Band Cement	75
Lingual Archwire	52-53
Lingual Brackets	30-32
Lingual Buttons & Cleats	59
Lingual Instruments	127-128
Lingual Wire Placer	132
Lip Bumpers	87
Lip Protector	114
Lip Ring Retractor	82

M

MacroCab+	78
Markers, Wire	52, 55
Marking Pens	94
Mathieu Hemostat	136
Measuring Dividers	137
Microbrush Applicators	78
Microetcher & Accessories	79
Mighty Chain	69
Mighty Ties Elastomers	67
Mini-Mold Kit, Tips	80
Mini-Screws, TADs	62-63
Mirrors	119-120
Mitchells Trimmer	133
Mixing Bowls	91
Mixing Pads	77
Model Archival System & Study Model Boxes	95
Model Base Formers	96
Model Boxes	95
Model Glow	96
Modelling Wax	96
Molar Bands	33-36
Mosquitos	133-136
Mouth Mirrors	137
Mouthguards	108-112
Mouthguard Material	98
MTM No Trace Lingual Bracket	30-31
Multi-Stranded Retainer Wire	61

N

Neckpads	87
NeoBand LC Cement	75
NeoBond LC Bracket Adhesive	72
NeoSentalloy Archwires	40
Nickel Free Archwire, Beta Titanium	64
Nickel Free Brackets, Tubes	65
Nickel Titanium Wire	42-43
NiTi Springs	54
Nitom Safety Facebow	87
No-Mix Adhesive	73
Nola Dry Field System, Components	81

O

Occlusal Contrastors	121
OmniArch Metal Bracket	20-21

OmniArch Plus Metal Bracket.....	22-23
Opal Retainer Material.....	97
Open Coil Springs.....	54
Optragate Extra Soft Lip & Cheek Retractor.....	83-122
Organisers.....	138-139
Ortho Bite Wax.....	96
Ortho FlexTech Retainer Wire.....	61
Ortho Model Archival Storage.....	95
Orthoprint Alginate.....	90
Ortho ReadyBrush.....	113
Ortho-Strips, Interproximal.....	101
OSAS Temporary Anchorage Device.....	62-63
Outie Tool.....	114
Ovation C.....	8-9
Ovation Metal Bracket.....	24-25
Overbite Ruler.....	137

P

Patient Instruction Videos.....	118
Patient Hygiene Kits.....	113
Patient Relief Wax.....	115
Pens & Pencils.....	94
Photography Cheek & Lip Retractors.....	122
Photographic Mirrors.....	119-120
Plaster.....	96
Pliers, Cutters.....	123-131
Plier Racks & Storage.....	139
Polishing Wheels & Burs.....	100
Porcelain Primer.....	74
Positive Positioner.....	134
Posted Stainless Steel Archwire.....	49
Prepasted Toothbrush.....	113
Primer.....	72, 74
Probes.....	133
Prophy Paste.....	78
Pure Plastics.....	97-98

R

Radiopaque Separators.....	70
Relief Wax, Silicone.....	115
Replicate Chromatic Alginate.....	89
Resolve Beta Titanium Archwire.....	46
Retainer Cases.....	116-117
Retainer Cleaner.....	107
Retainer Thermoforming Material.....	97
Retainer Retrievers.....	114
Retention, Wire & Lingual Retainers.....	61
Retract-EEZ Photo Lip Retractor.....	83, 122
Retractors.....	81-83, 122
Reverse Curve Archwire.....	47
Rotation Wedges.....	70
Ruler.....	137

S

Safety Glasses.....	84
Safety Release Module.....	87
Safety Swivel Key.....	137
Sani-Ties Elastomerics.....	66
Scissors.....	100
Scotchbrite Wheels.....	100
Screws, TADs.....	62-63
Self-ligating Brackets.....	6, 16, 18, 30, 32
Self-ligating Instruments.....	133
Sentalloy Archwires.....	40
Sentalloy, NeoSentalloy Lingual Archwire.....	52
Separating Plier.....	135
Separators.....	70
Shears, Large.....	100
Shock Doctor Mouthguards.....	108-111
Silicone Lubricating Spray.....	98
Silicone Patient Relief Wax.....	115
Silicone Polishers.....	100

Sili-Ties & Chain, Silicone Impregnated.....	66, 68
Snap-Fit Molar Bands.....	34
Solid Thread.....	69
Spacefile Interproximal Reduction Kit.....	102
Spacefiles.....	102
Spatulas.....	91
Splint Material.....	97
Sponge Pellets.....	77
Springs.....	54
Stainless Steel Archwire.....	48-49
Stainless Steel Chain Retainer Wire.....	61
Stainless Steel Ruler.....	137
Starlight Pro Curing Light.....	84
Stops, Crimpable.....	60
Study Model Boxes.....	95
Sunburst Chain.....	68
Super Chain.....	68

T

Temporary Anchorage Device, TADs.....	62-63
Tennis Instruments.....	123-128, 132, 134
TePe Interdental Brushes.....	113
Thermal Nickel Titanium Wire.....	40, 42-43
Thermoforming Plastics.....	97-98
Thread, Elastic.....	69
Ties, Elastomeric.....	66-67
Ties, Stainless Steel.....	55
TN3 Bracket Positioner.....	132
Tongue Filler.....	94
Tongue Tamers.....	60
Tooth Brushes.....	113
Tooth Coloured Archwire.....	51
Tooth Mousse.....	112
Tooth Stripping.....	101-104
Tracing Pad, Cephalometric.....	137
Tra-Tens Impression Trays.....	89
Travel Kit.....	113
Tri Cutter.....	99
Triad Gel.....	98
Tru-Grip Bracket Adhesives, Etch, Primer.....	73-74
Tru-Grip Glass Ionomer Band Cement.....	75
Tru-Grip Light Cure Band Cement.....	75
Tufted Brush.....	113
Tweezers.....	134-135
Twirl-On Module.....	132
Typodonts.....	114

U

U-flex Eruption Appliance.....	58
Ultrabright Glass Mirrors.....	120
Ultra Thread.....	69
Universal Archwires.....	42, 44-45
Utility Wax Strips.....	96

V

Vacuum Forming Machine.....	99
Verve Bondable Buccal Tubes.....	38
Verve Ceramic Bracket.....	12-13
Verve Metal Bracket.....	26-27
Verve Molar Bands.....	35

W

Wax, Bite.....	96
Wax, Patient.....	115
Whitening Tray Material.....	97
Wire Organiser.....	138
Wire Products.....	39-55
Wildcat Wire.....	55
Wonderfill Tongue Filler.....	94



discover the difference

The Orthodontic Company

T: 0117 975 5533 / **F:** 0117 975 5575 / **E:** info@tocdental.com

TOC, The Old Church, Collins Street, Avonmouth, Bristol BS11 9JJ